

Super-mini Signal Conditioners *Mini-M Series*

DC ALARM
(thumbwheel switch adjustment; single SPDT output)

MODEL **M2AS1**

MODEL & SUFFIX CODE SELECTION

M2AS1-□□□□-□□

MODEL _____
INPUT _____

Current	Voltage
A : 4 – 20mA DC	4 : 0 – 10V DC
	5 : 0 – 5V DC
	6 : 1 – 5V DC

ALARM OUTPUT _____

1 : Hi (coil energized at alarm)
2 : Hi (coil de-energized at alarm)
3 : Lo (coil energized at alarm)
4 : Lo (coil de-energized at alarm)

ON DELAY TIME _____

1 : 0.05 second	5 : 1 second
2 : 0.1 second	6 : 2 seconds
3 : 0.2 second	7 : 5 seconds
4 : 0.5 second	8 : 10 seconds

POWER ON DELAY TIME _____

1 : 1 second
2 : 2 seconds
3 : 3 seconds
4 : 4 seconds

POWER INPUT _____

AC Power	DC Power
M2 : 100 – 240V AC	R : 24V DC
	R2: 11 – 27V DC*
	P : 110V DC

*CE not available

STANDARDS & APPROVALS _____

/N : Without CE

/CE: CE marking

ORDERING INFORMATION

Specify code number. (e.g. M2AS1-6111-M2/CE)

GENERAL SPECIFICATIONS

Construction: Plug-in

Connection: M3 screw terminals (torque 0.8 N·m)

Housing material: Flame-resistant resin (black)

Isolation: Input to output to power

Setpoint adjustment: Thumbwheel switches (front);
0 – 99% independently; 1% increments

Hysteresis (deadband): Thumbwheel switches (front);
1 – 99% independently; 1% increments
(latching output when set to 00)

Front LED: Red light turns on when the coil is energized.

Overrange input: -14 to +113.5%

When the relay's untripped point relative to the preset alarm setpoint and deadband is out of this range, the relay remains latched.

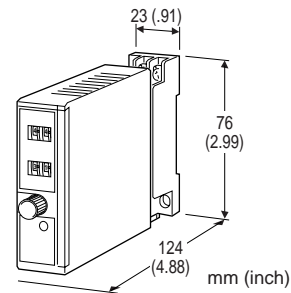

Functions & Features

- Provides a SPDT relay output at a preset DC input level
 - Thumbwheel switch setpoint adjustment
 - Adjustable deadband
 - Latching or non-latching output
 - Relays energized or de-energized at tripped condition
 - Flexible power input
 - High-density mounting
 - CE marking
- Typical Applications**
- Annunciator
 - Various alarm applications

Reset input: Latched output reset with the front control button or removely via base socket terminals.

INPUT & OUTPUT

■INPUT

•DC Current: 4 – 20mA DC; shunt resistor attached to input terminals (0.5W)

Input resistance: 250Ω

•DC Voltage: 0 – 10V DC, 0 – 5V DC or 1 – 5V DC

Input resistance: 1MΩ minimum

■RESET CONTACT INPUT

ON resistance: ≤1kΩ

OFF resistance: ≥50kΩ

■OUTPUT

•Relay Contact: 120V AC @5A (cosφ=1)
240V AC @2.5A (cosφ=1)
30V DC @5A (resistive load)
Electrical life 10⁵ cycles (rate 30/min.)

Maximum switching voltage: 250V AC or 30V DC

Maximum switching power: 600VA or 150W

Minimum load: 5V DC @10mA

Mechanical life: 5 × 10⁷ cycles

Alarm Trip Operation Terminal No. in parentheses

•Output Code : 1, 4

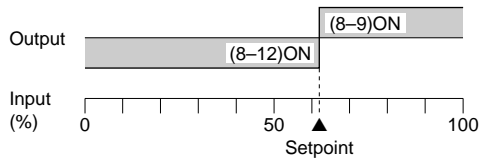

•Output Code : 2, 3

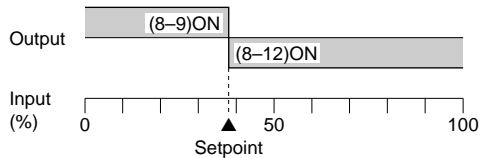

Trip Operation in Power Failure
: Terminals 8 – 12 turn ON.

PERFORMANCE in percentage of span

- Alarm setpoint accuracy: $\pm 0.5\%$
- Deadband setpoint accuracy: $\pm 0.5\%$
- Delay time (response time with 90% setpoint for a step input 0 – 100%)
 - Codes 1, 2: Rating ± 25 msec.
 - Codes 3 – 8: Rating $\pm 20\%$
- Power ON timer: Rating ± 0.5 sec.
- Trip point repeatability: $\pm 0.05\%$
- Temp. coefficient: $\pm 0.015\%/^{\circ}\text{C}$ ($\pm 0.008\%/^{\circ}\text{F}$)
- Line voltage effect: $\pm 0.1\%$ over voltage range
- Insulation resistance: $\geq 100\text{M}\Omega$ with 500V DC
- Dielectric strength: 2000V AC @1 minute
(input to output to power to ground)

INSTALLATION

Power input

- AC:** Operational voltage range 85 – 264V;
47 – 66 Hz;
approx. 3VA at 100V
approx. 4VA at 200V
approx. 5VA at 264V
- DC:** Operational voltage range for R: 24V
 $\pm 10\%$, R2: 11 – 27V, or P: 85 – 150V;
ripple 10% p-p max.; approx. 3W

- Operating temperature:** -5 to $+55^{\circ}\text{C}$ (23 to 131°F)
- Operating humidity:** 30 to 90% RH (non-condensing)
- Mounting:** Surface or DIN rail
- Dimensions:** W23xH76xD124 mm (0.91"x2.99"x4.88")
See General Spec. Sheet Figure A-2.
- Weight:** 150 g (0.33 lbs)
- Terminal assignment:** See General Spec. Sheet Figure B-2.

STANDARDS & APPROVALS

- CE conformity: EMC Directive (89/336/EEC)
 - EMI EN61000-6-4
 - EMS EN61000-6-2
- Low Voltage Directive (73/23/EEC)
 - Installation category II
 - Pollution degree 2
 - Max. operating voltage 300V
 - Input or output to power – Reinforced insulation
 - Input to output – Basic insulation

FRONT PANEL CONFIGURATION

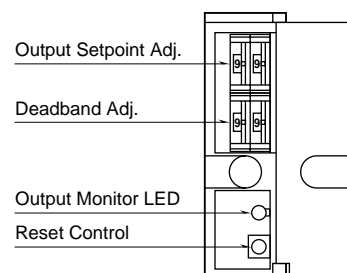

SCHEMATIC CIRCUITRY & CONNECTION DIAGRAM

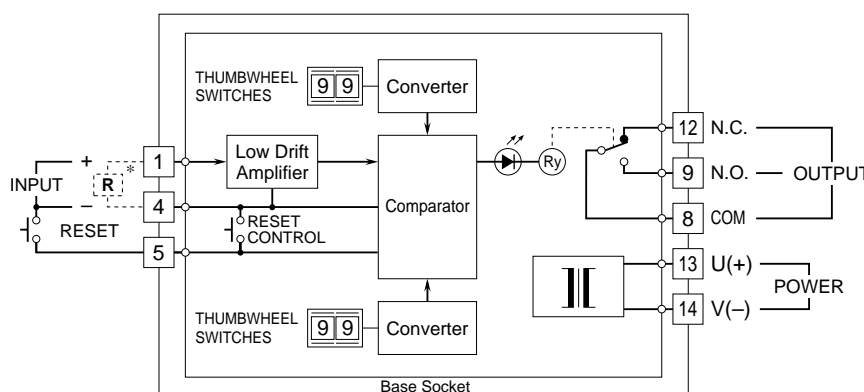

*Input shunt resistor attached for current input.

■Relay Protection

•AC Powered

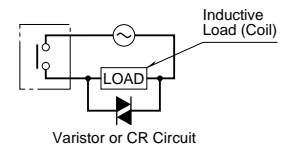

•DC Powered

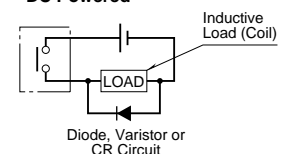

ALARM OPERATION & EFFECT OF TIMERS

■ **HIGH ALARM:** When the signal input exceeds the preset setpoint, the relay provides a tripped condition.

• **Hi Alarm**

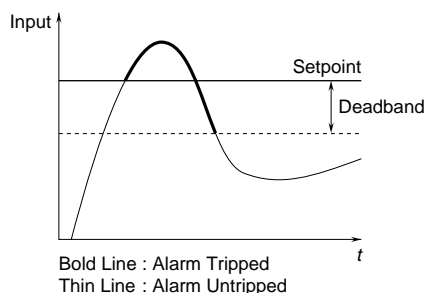

■ **LOW ALARM:** When the signal input goes below the preset setpoint, the relay provides a tripped condition.

• **Lo Alarm**

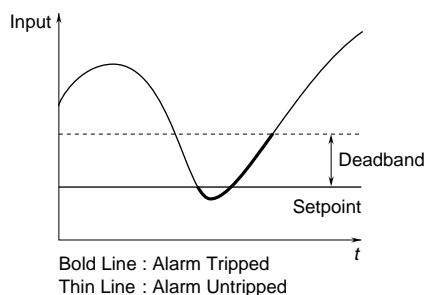

■ **ON DELAY TIME:** The relay status does not change until after the preset ON Delay Time (TD) once the signal input goes across the threshold.

• **ON Delay Time (TD) with Hi Alarm**

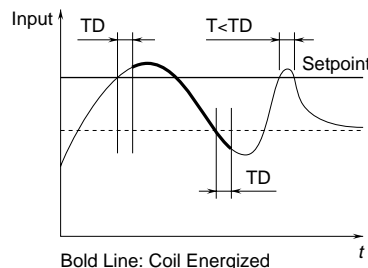

■ **POWER ON DELAY TIME:** The relay does not provide a tripped condition for a duration of the preset Power ON Delay Time (TDP) after the power supply is turned on, even when the signal input is in an alarm range.

• **Power ON Delay Time (TDP) with Hi Alarm**

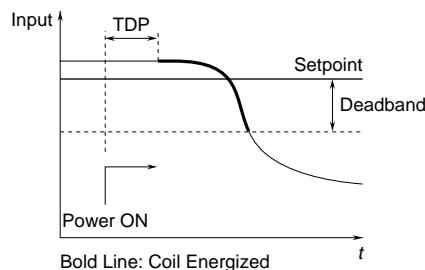

■ **LATCHING OUTPUT:** The relay does not return to an untripped condition once the signal input goes across the threshold, unless: (1) the Reset control button is pressed, (2) the Reset input terminal is closed, or (3) the power supply is removed.

• **Latching Output with Hi Alarm**

