

# **Minarik**

---

## **Variable Speed AC Motor Drives**

### **AC400 Series**

Installation and Operation Manual



# TABLE OF CONTENTS

- 1.0 GENERAL .....2
- 2.0 AC400 SPECIFICATIONS ..... 4
- 3.0 AC400 MODEL DESIGNATION CODE .....5
- 4.0 AC400 DIMENSIONS ..... 6
- 5.0 AC400 RATINGS .....10
- 6.0 THEORY .....14
- 7.0 INSTALLATION .....20
- 8.0 INPUT AC REQUIREMENTS .....22
- 9.0 VOLTAGE SELECTION .....23
- 10.0 POWER WIRING .....24
- 11.0 AC400 POWER WIRING DIAGRAM .....25
- 12.0 INITIAL POWER UP .....26
- 13.0 KEYPAD CONTROL .....28
- 14.0 CONTROL WIRING .....34
- 15.0 AC400 CONTROL WIRING DIAGRAMS .....39
- 16.0 PROGRAMMING THE AC400 DRIVE .....43
- 17.0 PARAMETER MENU .....46
- 18.0 DESCRIPTION OF PARAMETERS .....50
- 19.0 AC400 PID SETPOINT CONTROL .....77
- 20.0 TROUBLESHOOTING .....82
- 21.0 USER SETTING RECORD .....84

## **1.0 GENERAL**

### **1.1 PRODUCTS COVERED IN THIS MANUAL**

This manual covers the Minarik AC400 Series Variable Frequency Drive.

### **1.2 PRODUCT CHANGES**

Minarik Corporation reserves the right to discontinue or make modifications to the design of its products without prior notice, and holds no obligation to make modifications to products sold previously. Minarik Corporation also holds no liability for losses of any kind which may result from this action.

### **1.3 UNCONDITIONAL WARRANTY**

Minarik Corporation warrants the AC400 Series AC motor control to be free of defects in material and workmanship for a period of eighteen months from the date of sale to the user, or two years from the date of shipment, whichever ever occurs first. An AC400 Series control, or any component contained therein, which under normal use, becomes defective within the stated warranty time period, shall be returned to Minarik Corporation, freight prepaid, for examination (contact Minarik Corporation for authorization prior to returning any product). Minarik Corporation reserves the right to make the final determination as to the validity of a warranty claim, and sole obligation is to repair or replace only components which have been rendered defective due to faulty material or workmanship. No warranty claim will be accepted for components which have been damaged due to mishandling, improper installation, unauthorized repair and/or alteration of the product, operation in excess of design specifications or other misuse, or improper maintenance. Minarik Corporation makes no warranty that its products are compatible with any other equipment, or to any specific application, to which they may be applied and shall not be held liable for any other consequential damage or injury arising from the use of its products.

**This warranty is in lieu of all other warranties, expressed or implied. No other person, firm or corporation is authorized to assume, for Minarik Corporation, any other liability in connection with the demonstration or sale of its products.**

### **1.4 RECEIVING**

Inspect all cartons for damage which may have occurred during shipping. Carefully unpack equipment and inspect thoroughly for damage or shortage. Report any damage to carrier and/or shortages to supplier. All major components and connections should be examined for damage and tightness, with special attention given to PC boards, plugs, knobs and switches.

## **1.5 CUSTOMER MODIFICATION**

Minarik Corporation, its sales representatives and distributors, welcome the opportunity to assist our customers in applying our products. Many customizing options are available to aid in this function. Minarik Corporation cannot assume responsibility for any modifications not authorized by its engineering department.

## 2.0 AC400 SPECIFICATIONS

Storage Temperature	-20° to 70° C
Ambient Operating Temperature (With 2.5, 6, and 8 kHz carrier, derate for higher carriers)	Chassis -10° to 55° C Type 1 (IP 31) -10° to 50° C Type 4 (IP 65) -10° to 40° C Type 12 (IP 54) -10° to 40° C
Ambient Humidity	Less than 95% (non-condensing)
Maximum Altitude	3300 feet (1000 m) above sea level
Input Line Voltages	240/120 Vac , 240/200 Vac, 480/400 Vac, and 590/480 Vac
Input Voltage Tolerance	10%, -15%
Input Frequency Tolerance	48 to 62 Hz
Output Wave Form	Sine Coded PWM
Output Frequency	0-120 Hz
Carrier Frequency	2.5 kHz to 14 kHz
Frequency Stability	+ 0.00006% / °C
Efficiency	> 97% throughout speed range
Power Factor (displacement)	> 0.96
Service Factor	1.00
Overload Current Capacity	150% of output rating for 60 seconds 180% of output rating for 30 seconds
Speed Reference Follower	0-10 VDC, 4-20 mA
Control Voltage	15 VDC
Analog Outputs	0 - 10 VDC, or 2 - 10 VDC Proportional to speed or load
Digital Outputs	Form C relay: 2 A at 28 VDC or 120 Vac Open-collector outputs: 40 mA at 30 VDC

### 3.0 AC400 MODEL DESIGNATION CODE

The model number of an AC400 Series drive gives a full description of the basic drive unit (see example below).

EXAMPLE: AC424T-3.7P

(AC400, 480 VAC, 5 HP, Type 1 Enclosure, with a Remote Keypad Assembly)

	AC4	2	4	T	-3.7	P																		
<p><b>Series:</b> AC4 = AC400 Series Variable Speed AC Motor Drive</p>																								
<p><b>Enclosure Type:</b>            0 = Chassis - Open Enclosure with Door Removed            2 = NEMA 1 - General Purpose, vented            3 = NEMA 4 - Water-tight and Dust-tight            4 = NEMA 12 - Dust-tight and Drip-tight            5 = NEMA 4X - Water-tight, Dust-tight and Corrosion Resistant            6 = LARGER NEMA - General Purpose, vented (only applies to the 5 HP, 480/590V unit)</p>																								
<p><b>Input Voltage:</b>            1 = 240/120 Vac (For 110, 115, 120, 230 and 240 Vac; 50 or 60 Hz)            2 = 240/200 Vac (For 208 and 240 Vac; 50 or 60 Hz)            4 = 480/400 Vac (For 380, 415, 440, 460 and 480 Vac; 50 or 60 Hz)            5 = 590/480 Vac (For 440, 460, 480, 575 and 600 Vac; 50 or 60 Hz)</p>																								
<p><b>Input:</b>            S = Single phase input.            T = Three phase input</p>																								
<p><b>Horsepower:</b></p> <table style="width: 100%; border: none;"> <tr> <td>0.2 = ¼ Hp</td> <td>3.7 = 5 Hp</td> <td>22 = 30 Hp</td> </tr> <tr> <td>0.4 = ½ Hp</td> <td>5.5 = 7½ Hp</td> <td>30 = 40 Hp</td> </tr> <tr> <td>0.75 = 1 Hp</td> <td>7.5 = 10 Hp</td> <td>37 = 50 Hp</td> </tr> <tr> <td>1.1 = 1½ Hp</td> <td>11.0 = 15 Hp</td> <td>45 = 60 Hp</td> </tr> <tr> <td>1.5 = 2 Hp</td> <td>15.0 = 20 Hp</td> <td></td> </tr> <tr> <td>2.2 = 3 Hp</td> <td>18.5 = 25 Hp</td> <td></td> </tr> </table>							0.2 = ¼ Hp	3.7 = 5 Hp	22 = 30 Hp	0.4 = ½ Hp	5.5 = 7½ Hp	30 = 40 Hp	0.75 = 1 Hp	7.5 = 10 Hp	37 = 50 Hp	1.1 = 1½ Hp	11.0 = 15 Hp	45 = 60 Hp	1.5 = 2 Hp	15.0 = 20 Hp		2.2 = 3 Hp	18.5 = 25 Hp	
0.2 = ¼ Hp	3.7 = 5 Hp	22 = 30 Hp																						
0.4 = ½ Hp	5.5 = 7½ Hp	30 = 40 Hp																						
0.75 = 1 Hp	7.5 = 10 Hp	37 = 50 Hp																						
1.1 = 1½ Hp	11.0 = 15 Hp	45 = 60 Hp																						
1.5 = 2 Hp	15.0 = 20 Hp																							
2.2 = 3 Hp	18.5 = 25 Hp																							
<p><b>Interface Options:</b>            P = Remote Keypad Assembly            No character when this type of option is not specified.</p>																								
<p><b>Standard Options:</b>            H = Additional Form "C" Relay circuit board            J = Dynamic Braking circuit board            K = Additional Relay &amp; Dynamic Braking board (not available on all HP sizes – consult factory)            No character when this type of option is not specified.</p>																								

# 4.0 AC400 DIMENSIONS

## 4.1 CHASSIS AND TYPE 1 ENCLOSED

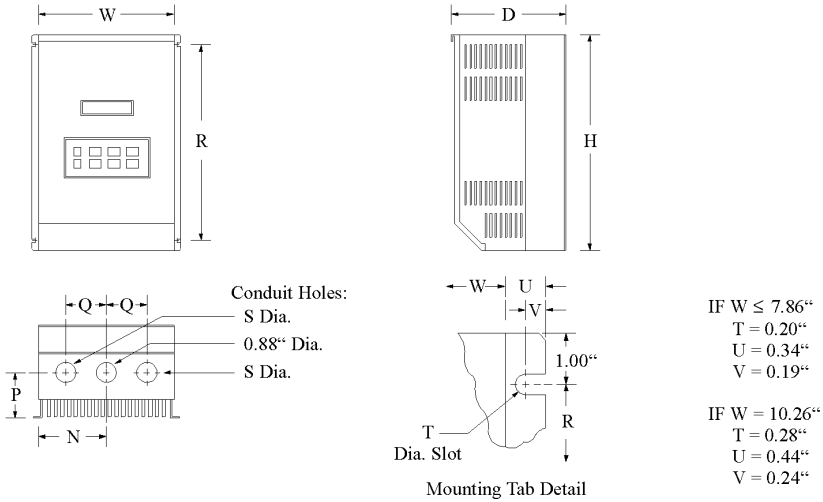

HP	INPUT VOLTAGE	MODEL	H	W	D	N	P	Q	R	S
0.25	240 / 120	AC421S-0.2	7.50	4.70	3.33	2.35	1.60	1.37	5.50	0.88
0.5	240 / 120	AC421S-0.4	7.50	6.12	3.63	3.77	1.80	1.37	5.50	0.88
	240	AC422S-0.4	7.50	4.70	3.63	2.35	1.90	1.37	5.50	0.88
	240 / 200	AC422T-0.4	7.50	4.70	3.63	2.35	1.90	1.37	5.50	0.88
1	240 / 120	AC421S-0.75	7.50	6.12	4.22	3.77	2.40	1.37	5.50	0.88
	240	AC422S-0.75	7.50	4.70	4.33	2.35	2.60	1.37	5.50	0.88
	240 / 200	AC422T-0.75	7.50	4.70	4.33	2.35	2.60	1.37	5.50	0.88
	480 / 400	AC424T-0.75	7.50	4.70	3.63	2.35	1.90	1.37	5.50	0.88
	590	AC425T-0.75	7.50	4.70	3.63	2.35	1.90	1.37	5.50	0.88
1.5	240 / 120	AC421S-1.1	7.50	6.12	4.22	3.77	2.40	1.37	5.50	0.88
	240	AC422S-1.1	7.50	6.12	4.22	3.77	2.40	1.37	5.50	0.88
	240 / 200	AC422T-1.1	7.50	4.70	4.33	2.35	2.60	1.37	5.50	0.88
2	240	AC422S-1.5	7.50	6.12	5.12	3.77	3.30	1.37	5.50	0.88
	240 / 200	AC422T-1.5	7.50	6.12	5.12	3.77	3.30	1.37	5.50	0.88
	480 / 400	AC424T-1.5	7.50	6.12	4.22	3.77	2.40	1.37	5.50	0.88
	590	AC425T-1.5	7.50	6.12	4.22	3.77	2.40	1.37	5.50	0.88
3	240	AC422S-2.2	7.50	6.12	5.12	3.77	3.3	1.37	5.5	0.88
	240 / 200	AC422T-2.2	7.50	6.12	5.12	3.77	3.3	1.37	5.5	0.88
	480 / 400	AC424T-2.2	7.50	6.12	5.12	3.77	3.3	1.37	5.5	0.88
	590	AC425T-2.2	7.50	6.12	5.12	3.77	3.3	1.37	5.5	0.88



**DIMENSIONS - CHASSIS AND TYPE 1 ENCLOSED (continued)**

HP	INPUT VOLTAGE	MODEL	H	W	D	N	P	Q	R	S
5	240 / 200	AC422T-3.7	7.88	7.86	5.94	5.13	3.95	1.50	5.88	1.13
	480 / 400	AC424T-3.7	7.50	6.12	5.12	3.77	3.30	1.37	5.50	0.88
	590	AC465T-3.7	7.88	7.86	5.94	5.13	3.95	1.50	5.58	1.13
7.5	240 / 200	AC422T-5.5	9.38	7.86	6.84	3.93	4.19	2.00	5.88	1.13
	480 / 400	AC424T-5.5	9.38	7.86	6.25	5.13	3.95	1.50	7.38	1.13
	590	AC425T-5.5	9.38	7.86	6.25	5.13	3.95	1.50	7.38	1.13
10	240 / 200	AC422T-7.5	11.25	7.86	6.84	3.93	4.19	2.00	7.75	1.38
	480 / 400	AC424T-7.5	9.38	7.86	6.84	3.93	4.19	2.00	5.88	1.13
	590	AC425T-7.5	9.38	7.86	7.40	3.93	4.19	2.00	5.88	1.13
15	240 / 200	AC422T-11	12.75	7.86	6.84	3.93	4.19	2.00	9.25	1.38
	480 / 400	AC424T-11	11.25	7.86	6.84	3.93	4.19	2.00	7.75	1.38
	590	AC425T-11	12.75	7.86	6.84	3.93	4.19	2.00	9.25	1.38
20	240 / 200	AC422T-15	12.75	10.26	7.74	5.13	5.00	2.50	9.25	1.38
	480 / 400	AC424T-15	12.75	7.86	6.84	3.93	4.19	2.00	9.25	1.38
	590	AC425T-15	12.75	7.86	7.40	3.93	4.19	2.00	9.25	1.38
25	240 / 200	AC422T-18.5	15.75	10.26	8.35	5.13	5.00	2.50	12.25	1.38
	480 / 400	AC424T-18.5	12.75	10.26	7.74	5.13	5.00	2.50	9.25	1.38
	590	AC425T-18.5	12.75	10.26	7.74	5.13	5.00	2.50	9.25	1.38
30	240 / 200	AC422T-22	15.75	10.26	8.35	5.13	5.00	2.50	12.25	1.38
	480 / 400	AC424T-22	12.75	10.26	7.74	5.13	5.00	2.50	9.25	1.38
	590	AC425T-22	12.75	10.26	8.25	5.13	5.00	2.50	9.25	1.38
40	480/400	AC424T-30	15.75	10.26	8.35	5.13	5.75	2.50	12.25	1.38
	590	AC425T-30	15.75	10.26	8.35	5.13	5.75	2.50	12.25	1.38
50	480 / 400	AC424T-37	19.75	10.26	8.55	5.13	5.75	2.50	16.25	1.75
	590	AC425T-37	19.75	10.26	8.55	5.13	5.75	2.50	16.25	1.75
60	480 / 400	AC424T-45	19.75	10.26	8.55	5.13	5.75	2.50	16.25	1.75
	590	AC425T-45	19.75	10.26	8.55	5.13	5.75	2.50	16.25	1.75

## 4.2 TYPE 4, 4X, AND 12 ENCLOSED

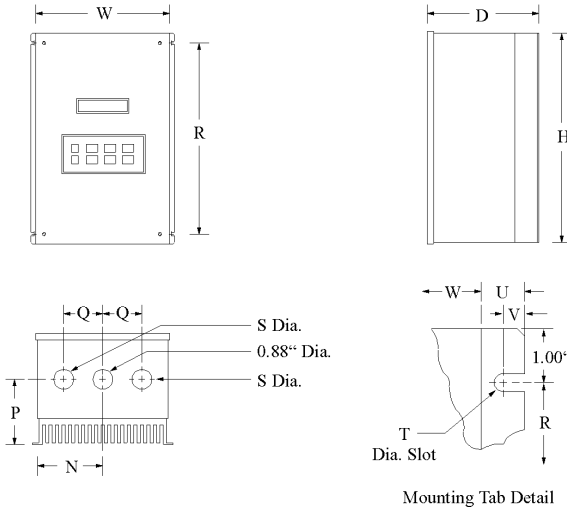

HP	INPUT VOLTAGE	MODEL	H	W	D	N	P	Q	R	S
0.25	240 / 120	AC4x1S-0.2	7.88	6.12	3.63	3.06	2.00	1.37	5.88	0.88
0.5	240 / 120	AC4x1S-0.4	7.88	7.86	3.75	4.80	2.10	1.37	5.88	0.88
	240	AC4x2S-0.4	7.88	6.12	4.35	3.06	2.70	1.37	5.88	0.88
	240 / 200	AC4x1T-0.4	7.88	6.12	4.35	3.06	2.70	1.37	5.88	0.88
1	240 / 120	AC4x1S-0.75	7.88	7.86	4.90	4.80	3.25	1.37	5.88	0.88
	240	AC4x2S-0.75	7.88	6.12	4.35	3.06	2.70	1.37	5.88	0.88
	240 / 200	AC4x2T-0.75	7.88	6.12	4.35	3.06	2.70	1.37	5.88	0.88
	480 / 400	AC4x4T-0.75	7.88	6.12	4.35	3.06	2.70	1.37	5.88	0.88
	590	AC4x5T-0.75	7.88	6.12	4.35	3.06	2.70	1.37	5.88	0.88
1.5	240 / 120	AC4x1S-1.1	7.88	7.86	4.90	4.80	3.25	1.37	5.88	0.88
	240	AC4x2S-1.1	7.88	7.86	4.90	4.80	3.25	1.37	5.88	0.88
	240 / 200	AC4x2T-1.1	7.88	6.12	5.25	3.06	3.60	1.37	5.88	0.88
2	240	AC4x2S-1.5	7.88	7.86	4.90	4.80	3.25	1.37	5.88	0.88
	240 / 200	AC4x2T-1.5	7.88	7.86	4.90	4.80	3.25	1.37	5.88	0.88
	480 / 400	AC4x4T-1.5	7.88	7.86	4.90	4.80	3.25	1.37	5.88	0.88
	590	AC4x5T-1.5	7.88	7.86	4.90	4.80	3.25	1.37	5.88	0.88
3	240	AC4x2S-2.2	7.88	7.86	5.90	4.80	4.25	1.37	5.88	0.88
	240 / 200	AC4x2T-2.2	7.88	7.86	5.90	4.80	4.25	1.37	5.88	0.88
	480 / 400	AC4x4T-2.2	7.88	7.86	4.90	4.80	3.25	1.37	5.88	0.88
	590	AC4x5T-2.2	7.88	7.86	4.90	4.80	3.25	1.37	5.88	0.88

\*x = 3, 4, or 5

**DIMENSIONS - TYPE 4, 4X, AND 12 ENCLOSED (continued)**

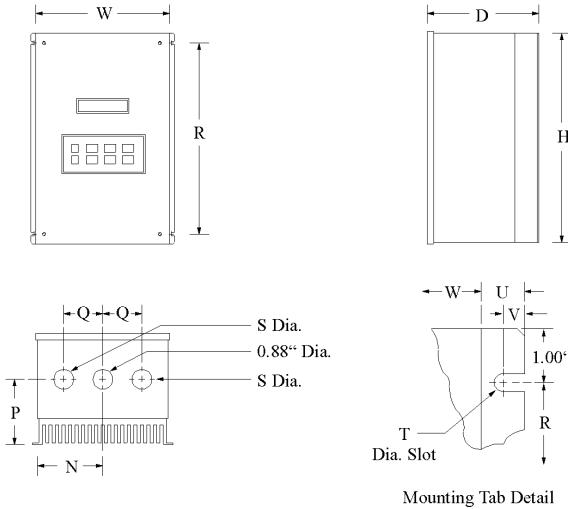

IF  $W \leq 7.86''$   
 $T = 0.20''$   
 $U = 0.34''$   
 $V = 0.19''$

IF  $W = 10.26''$   
 $T = 0.28''$   
 $U = 0.44''$   
 $V = 0.24''$

HP	INPUT VOLTAGE	MODEL	H	W	D	N	P	Q	R	S
3	240	AC4x2S-2.2	7.88	7.86	5.9	4.8	4.25	1.37	5.88	0.88
	240 / 200	AC4x2T-2.2	7.88	7.86	5.9	4.8	4.25	1.37	5.88	0.88
	480 / 400	AC4x4T-2.2	7.88	7.86	4.9	4.8	3.25	1.37	5.88	0.88
	590	AC4x5T-2.2	7.88	7.86	4.9	4.8	3.25	1.37	5.88	0.88
5	240 / 200	AC4x2T-3.7	9.75	10.26	7.20	5.13	5.25	2.00	7.75	1.13
	480 / 400	AC4x4T-3.7	7.88	7.86	5.90	4.80	4.25	1.37	5.88	0.88
	590	AC4x5T-3.7	7.88	7.86	5.90	4.80	4.25	1.37	5.88	0.88
7.5	240 / 200	AC4x2T-5.5	11.75	10.26	8.35	5.13	5.75	2.00	9.75	1.38
	480 / 400	AC4x4T-5.5	9.75	10.26	7.20	5.13	5.25	2.00	7.75	1.13
	590	AC4x5T-5.5	9.75	10.26	7.20	5.13	5.25	2.00	7.75	1.13
10	240 / 200	AC4x2T-7.5	13.75	10.26	8.35	5.13	5.75	2.00	11.75	1.38
	480 / 400	AC4x4T-7.5	11.75	10.26	8.35	5.13	5.75	2.00	9.75	1.13
	590	AC4x5T-7.5	11.75	10.26	8.35	5.13	5.75	2.00	9.75	1.13
15	240 / 200	AC4x2T-11	15.75	10.26	8.35	5.13	5.75	2.00	13.75	1.38
	480 / 400	AC4x4T-11	13.75	10.26	8.35	5.13	5.75	2.00	11.75	1.38
	590	AC4x5T-11	13.75	10.26	8.35	5.13	5.75	2.00	11.75	1.38
20	240 / 200	AC442T-15	15.75	10.26	8.35	5.13	5.75	2.00	11.75	1.38
	480 / 400	AC4x4T-15	15.75	10.26	8.35	5.13	5.75	2.00	13.75	1.38
	590	AC4x5T-15	15.75	10.26	8.35	5.13	5.75	2.00	13.75	1.38
25	480 / 400	AC444T-18.5	15.75	10.26	8.35	5.13	5.75	2.00	11.75	1.38
	590	AC445T-18.5	15.75	10.26	8.35	5.13	5.75	2.00	11.75	1.38
30	480 / 400	AC444T-22	15.75	10.26	8.35	5.13	5.75	2.00	11.75	1.38
	590	AC445T-22	15.75	10.26	8.35	5.13	5.75	2.00	11.75	1.38

\*x = 3, 4, or 5

## 5.0 AC400 RATINGS

The following tables indicate the input and output ratings of the AC400 Series drive.

**NOTE:** The output current ratings are based no operation at carrier frequencies of 8 kHz and below. At full ambient temperature, operation at carrier frequencies above 8 kHz require derating the drive by multiplying the output current rating by the following factors: 0.94 at 10 kHz, 0.89 at 12 kHz, and 0.83 at 14 kHz. Refer to Parameter 23 (CARRIER) in Section 18.0 (DESCRIPTION OF PARAMETERS).

AC4x1 SERIES RATINGS						
MODEL		INPUT (240 / 120 VAC, 50 - 60 Hz)			OUTPUT (0 - 230 VAC)	
MODEL NUMBER (NOTE 1)	RATED HP	INPUT PHASE	NOMINAL CURRENT (AMPS) (NOTE 2)	POWER (KVA)	NOMINAL CURRENT (AMPS) (NOTE 2)	POWER (KVA)
AC4x1S-0.2	0.25	1	3.0 / 6.0	0.72	1.4	0.56
AC4x1S-0.4	0.5	1	4.6 / 9.2	1.1	2.2	0.88
AC4x1S-0.75	1	1	8.1 / 16.2	1.9	4.0	1.6
AC4x1S-1.1	1.5	1	10.4 / 20.8	2.5	5.2	2.1
NOTE 1: See Section 3.0 for model number breakdown. NOTE 2: The higher current rating is for 120 Vac input and the lower current rating is or 240 Vac input. NOTE 3: See Section 8.0 for recommended fuse type.						

## AC4x2 SERIES RATINGS

MODEL		INPUT (240 VAC, 50 - 60 Hz)			OUTPUT (0 - 230 VAC)	
MODEL NUMBER (NOTE 1)	RATED HP	INPUT PHASE	NOMINAL CURRENT (AMPS) (NOTE 2)	POWER (KVA)	NOMINAL CURRENT (AMPS) (NOTE 2)	POWER (KVA)
AC4x2S-0.4	1/2	1	5.0	1.2	2.2	0.9
AC4x2T-0.4	1/2	3	2.7	1.1	2.2	0.9
AC4x2S-0.75	1	1	9.0	2.2	4.0	1.6
AC4x2T-0.75	1	3	4.8	2.0	4.0	1.6
AC4x2S-1.1	1.5	1	11.6	2.8	5.2	2.1
AC4x2T-1.1	1.5	3	6.2	2.6	5.2	2.1
AC4x2S-1.5	2	1	14.9	3.6	6.8	2.7
AC4x2T-1.5	2	3	8.1	3.4	6.8	2.7
AC4x2S-2.2	3	1	20.9	5.0	9.6	3.8
AC4x2T-2.2	3	3	11.3	4.7	9.6	3.8
AC4x2T-3.7	5	3	17.7	7.4	15.2	6.1
AC4x2T-5.5	7.5	3	25.5	10.6	22.0	8.8
AC4x2T-7.5	10	3	31.8	13.2	28.0	11.2
AC4x2T-11	15	3	47.6	19.8	42.0	16.7
AC4x2T-15	20	3	61.0	25.3	54.0	21.5
AC4x2T-18.5	25	3	77.0	32.0	68.0	27.1
AC4x2T-22	30	3	90.4	37.6	80.0	31.9

NOTE 1: See Section 3.0 for model number breakdown.

NOTE 2: For 200 VAC input voltage on THREE PHASE MODELS ONLY, multiply the input and output current ratings by 1.15 and the output voltage by 0.87.

NOTE 3: See Section 8.0 for recommended fuse type.

## AC4x4 SERIES RATINGS

MODEL		INPUT (480 Vac, 50 - 60 Hz)			OUTPUT (0 - 460 Vac)	
MODEL NUMBER (NOTE 1)	RATED HP	INPUT PHASE	NOMINAL CURRENT (AMPS) (NOTE 2)	POWER (KVA)	NOMINAL CURRENT (AMPS) (NOTE 2)	POWER (KVA)
AC4x4T-0.75	1	3	2.4	2.0	2.0	1.6
AC4x4T-1.5	2	3	4.1	3.4	3.4	2.7
AC4x4T-2.2	3	3	5.7	4.7	4.8	3.8
AC4x4T-3.7	5	3	8.9	7.3	7.6	6.1
AC4x4T-5.5	7.5	3	12.8	10.6	11.0	8.8
AC4x4T-7.5	10	3	15.9	13.2	14.0	11.2
AC4x4T-11	15	3	23.8	19.8	21.0	16.7
AC4x4T-15	20	3	30.5	25.3	27.0	21.5
AC4x4T-18.5	25	3	38.4	31.9	34.0	27.1
AC4x4T-22	30	3	45.2	37.6	40.0	31.9
AC4x4T-30	40	3	59.0	49.0	52.0	41.4
AC4x4T-37	50	3	74.0	61.5	65.0	51.8
AC4x4T-45	60	3	87.0	72.3	77.0	61.3

NOTE 1: See Section 3.0 for model number breakdown.

NOTE 2: For 400 Vac input voltage, multiply the input and output current ratings by 1.15 and the output voltage by 0.87.

NOTE 3: See Section 8.0 for recommended fuse type.

## AC4x5 SERIES RATINGS

MODEL		INPUT (590 VAC, 50 - 60 Hz)			OUTPUT (0 - 575 VAC)	
MODEL NUMBER (NOTE 1)	RATED HP	INPUT PHASE	NOMINAL CURRENT (AMPS) (NOTE 2)	POWER (KVA)	NOMINAL CURRENT (AMPS) (NOTE 2)	POWER (KVA)
AC4x5T-0.75	1	3	1.9	1.9	1.6	1.6
AC4x5T-1.5	2	3	3.3	3.4	2.7	2.7
AC4x5T-2.2	3	3	4.6	4.7	3.9	3.9
AC4x5T-3.7	5	3	7.1	7.3	6.1	6.1
AC4x5T-5.5	7.5	3	10.5	10.7	9.0	8.8
AC4x5T-7.5	10	3	12.5	12.8	11.0	11.0
AC4x5T-11	15	3	19.3	19.7	17.0	16.9
AC4x5T-15	20	3	24.9	25.4	22.0	21.5
AC4x5T-18.5	25	3	30.5	31.2	27.0	26.9
AC4x5T-22	30	3	36.2	37.1	32.0	31.9
AC4x5T-30	40	3	46.5	47.5	41.0	40.8
AC4x5T-37	50	3	59.0	60.3	52.0	51.8
AC4x5T-45	60	3	71.0	72.5	62.0	61.7

NOTE 1: See Section 3.0 for model number breakdown.

NOTE 2: For 480 VAC input voltage, multiply the input power, output power, and output voltage by 0.83. Output current remains the same.

NOTE 3: See Section 8.0 for recommended fuse type.

## 6.0 THEORY

### 6.1 DESCRIPTION OF AC MOTOR OPERATION

Three phase AC motors are comprised of two major components, the stator and the rotor. The stator is a set of three electrical windings held stationary in the motor housing. The rotor is a metal cylinder, fixed to the motor drive shaft, which rotates within the stator. The arrangement of the stator coils and the presence of three phase AC voltage give rise to a rotating magnetic field which drives the rotor. The speed at which the magnetic field rotates is known as the synchronous speed of the motor. Synchronous speed is a function of the frequency at which the voltage is alternating and the number of poles in the stator windings.

The following equation gives the relation between synchronous speed, frequency, and the number of poles:

$$S_s = 120 f/p$$

Where:  $S_s$  = Synchronous speed (rpm ),  $f$  = frequency (Hz),  
 $p$  = number of poles

In three phase induction motors the actual shaft speed differs from the synchronous speed as load is applied. This difference is known as “slip”. Slip is commonly expressed as a percentage of synchronous speed. A typical value is three percent at full load.

The strength of the magnetic field in the gap between the rotor and stator is proportional to the amplitude of the voltage at a given frequency. The output torque capability of the motor is, therefore, a function of the applied voltage amplitude at a given frequency. When operated below base (rated) speed, AC motors run in the range of “constant torque”. Constant torque output is obtained by maintaining a constant ratio between voltage amplitude (Volts) and frequency (Hertz). For 60 Hz motors rated at 230, 460, and 575 Vac, common values for this V/Hz ratio are 3.83, 7.66, and 9.58 respectively. Operating with these V/Hz ratios generally yields optimum torque capability. Operating at lower ratio values results in lower torque and power capability. Operating at higher ratio values will cause the motor to overheat. Most standard motors are capable of providing full torque output from 3 to 60 Hz. However, at lower speeds, where motor cooling fans become less effective, supplemental cooling may be needed to operate at full torque output continuously.



If the frequency applied to the motor is increased while the voltage remains constant, torque capability will decrease as speed increases. This will cause the horsepower capability of the motor to remain approximately constant. Motors run in this mode when operated above base speed, where drive output voltage is limited by the input line voltage. This operating range is known as the “constant horsepower” range. The typical maximum range for constant horsepower is about 2.3 to 1 (60 to 140 Hz). The diagram below depicts the characteristics of a typical AC induction motor with a 60 Hz base speed.



**Warning**  
Consult motor manufacturer before operating motor and/or drive equipment above base speed.

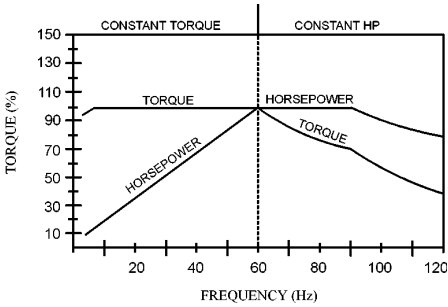

### 6.1.1 VARIABLE TORQUE VS. CONSTANT TORQUE

Variable frequency drives, and the loads they are applied to, can generally be divided into two groups: constant torque and variable torque. Constant torque loads include: vibrating conveyors, punch presses, rock crushers, machine tools, and just about every other application that is not considered variable torque. Variable torque loads include centrifugal pumps and fans, which make up the majority of HVAC applications.

Variable torque loads are governed by the affinity laws, which define the relationships between speed, flow, torque and horsepower. The following diagram illustrates these relationships:

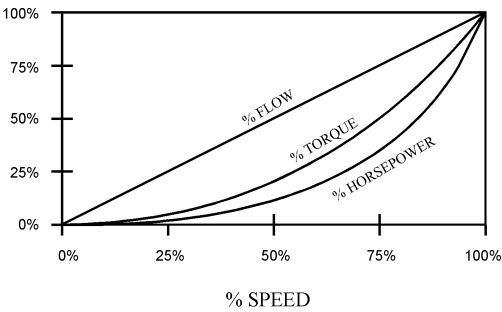

“Variable torque” refers to the fact that the torque required varies with the square of the speed. Also, the horsepower required varies with the cube of the speed, resulting in a large reduction in horsepower for even a small reduction in speed. It is easily seen that substantial energy savings can be achieved by reducing the speed of a fan or pump. For example, reducing the speed to 50% results in a 50 HP motor having to produce only 12.5% of rated horsepower, or 6.25 HP. Variable torque drives usually have a low overload capacity (110% - 120% for 60 seconds), because variable torque applications rarely experience overload conditions. To optimize efficiency and energy savings, variable torque drives are usually programmed to follow a variable V/Hz ratio.

The term “constant torque” is not entirely accurate in terms of the actual torque required for an application. Many constant torque applications have reciprocating loads, such as vibrating conveyors and punch presses, where the rotational motion of the motor is being converted to a linear motion. In such cases, the torque required can vary greatly at different points in the cycle. For constant torque loads, this fluctuation in torque is not a direct function of speed, as it is with a variable torque load. As a result, constant torque drives typically have a high overload rating (150% for 60 seconds) in order to handle the higher peak torque demands. To achieve maximum torque, constant torque drives follow a constant V/Hz ratio.

Both AC300 & AC400 Series product lines have full overload capacity (150% for 60 seconds, 180% for 30 seconds), so that either one can be used for either type of application. The V/Hz ratio can also be changed to optimize performance for either type of application.

## **6.2 DRIVE FUNCTION DESCRIPTION**

The AC400 Series is a 16 bit microprocessor based, keypad programmable, variable speed AC motor drive. There are four major sections: an input diode bridge and filter, a power board, a control board, and an output intelligent power module.

### **6.2.1 DRIVE OPERATION**

Incoming AC line voltage is converted to a pulsating DC voltage by the input diode bridge. The DC voltage is supplied to the bus filter capacitors through a charge circuit which limits inrush current to the capacitors during power-up. The pulsating DC voltage is filtered by the bus capacitors which reduces the ripple level. The filtered DC voltage enters the inverter section of the drive, composed of six output intelligent insulated gate bi-polar transistors (IGBTs) which make up the three output legs of the drive. Each leg has one intelligent IGBT connected to the positive bus voltage and one connected to the negative bus voltage. Alternately switching on each leg, the intelligent IGBT produces an alternating voltage on each of the corresponding motor windings. By switching each output intelligent IGBT at a very high frequency (known as the carrier frequency) for varying time intervals, the inverter is able to produce a smooth, three phase, sinusoidal output current wave which optimizes motor performance.

## 6.2.2 CIRCUIT DESCRIPTION

The control section consists of a control board with a 16 bit microprocessor, keypad and display. Drive programming is accomplished via the keypad or the serial communications port. During operation the drive can be controlled via the keypad, by control devices wired to the control terminal strip, or by the the serial communications port. The Power Board contains the control and protection circuits which govern the six output IGBTs. The Power Board also contains a charging circuit for the bus filter capacitors, a motor current feedback circuit, a voltage feedback circuit, and a fault signal circuit. The drive has several built in protection circuits. These include phase-to-phase and phase-to-ground short circuit protection, high and low line voltage protection, protection against excessive ambient temperature, and protection against continuous excessive output current. Activation of any of these circuits will cause the drive to shut down in a fault condition.

## 6.2.3 AC400 ANALOG INPUT SIGNALS

The drive allows for three speed reference input signals: speed potentiometer (10,000 Ohm), 4-20 mA, or 0-10 VDC. For control by a speed pot, the wiper lead is connected to terminal TB-5A, and the high and low end leads are connected to terminals TB-6 and TB-2, respectively. For 4-20 mA control, wire the positive to terminal TB-5B and the negative to terminal TB-2. For 0-10 VDC control, wire the positive to terminal TB-5A and the negative to terminal TB-2. Refer to the diagrams in Section 15.0 - AC400 CONTROL WIRING DIAGRAMS.

The input impedance of terminal TB-5A (0-10 VDC input) is 200 kilohms, and the input impedance of terminal TB-5B (4-20 mA input) is 100 ohms. Terminal TB-2 is circuit common.

## 6.2.4 AC400 ANALOG OUTPUT SIGNALS

There are two terminals that can supply analog output signals proportional to output frequency or load. Terminal TB-10A can provide a 0-10 VDC or a 2-10 VDC signal proportional to output frequency, and TB-10B can provide the same signals proportional to load. The 2-10 VDC signals can be converted to a 4-20 mA signal using a resistor in series with the signal such that the total circuit resistance is 500 Ohms. See Parameters: 42 - TB10A OUT, 43 - @TB10A, 44 - TB10B OUT, and 45 - @TB10B in Section 18.0 - DESCRIPTION OF PARAMETERS.

**NOTE:** These analog output signals cannot be used with “loop-powered” devices that derive power from a 4-20 mA signal.

### 6.2.5 AC400 STATUS OUTPUT RELAYS

The control board has one Form C relay at terminals TB-16, TB-17, and TB-18. Contacts are rated for 2 amps at 28 VDC or 120 Vac.

There are also two open-collector outputs at terminals TB-14 and TB-15. The open-collector circuit is a current sinking type rated at 30 VDC and 40 mA maximum. An external power supply (30 VDC max.) must be used to power the open-collector outputs. The drive does not have a dedicated power supply for the open-collector outputs.

The Form C relay and the open-collector outputs can be programmed to indicate any of the following: RUN, FAULT, /FAULT (INVERSE FAULT), LOCK (FAULT LOCKOUT), @ SPEED (AT SPEED), ABOVE #3, I LIMIT (CURRENT LIMIT), AUTO/MAN mode, FLWR PR (FOLLOWER PRESENT), or MIN/MAX (MIN/MAX ALARM). See Parameters: 52 (TB14 OUT), 53 (TB15 OUT), and 54 (RELAY), in Section 18.0 - DESCRIPTION OF PARAMETERS.

The following describes the possible relay output settings:

- NONE**                      This setting disables the relay output.
  
- RUN**                        The relay energizes when the drive is given a START command, and remains energized until: a STOP command is given and the output frequency has decelerated to 0.5 Hz, the drive has “tripped”, or the input voltage is removed. Note that this relay indicates only that the drive is in the RUN mode. It does not necessarily indicate that the motor is turning.
  
- FAULT**                      The relay energizes when input voltage is applied to the drive and remains energized until the drive “trips” into a fault condition, or input voltage is removed.
  
- / FAULT**                    INVERSE FAULT - The relay energizes when the drive “trips” into a fault condition, and remains energized until the fault condition is cleared.
  
- LOCK**                        FAULT LOCKOUT - This relay is used when the drive is programmed to automatically restart after a fault. The relay energizes when input voltage is applied to the drive and remains energized until the drive has faulted and unsuccessfully attempted five restarts, or input voltage is removed.

- @ SPEED** AT SPEED - The relay energizes when the drive reaches the speed setpoint. To avoid a “chattering” relay (energizing and de-energizing), due to small fluctuations in speed, the relay will remain energized as long as the actual speed is within + 3 Hz of the speed setpoint.
- ABOVE #3** ABOVE SPEED #3 - The relay energizes when the output frequency exceeds the SPEED #3 value, and de-energizes when the output frequency returns to a value lower than the SPEED #3 value. See Parameter 3 - SPEED #3 in Section 18.0 - DESCRIPTION OF PARAMETERS.
- I LIMIT** CURRENT LIMIT - The relay energizes when the drive is operating in current limit. Once the current limit relay is energized, it remains energized for a minimum of 500ms, regardless of whether the drive is still in current limit. At the end of the 500ms interval, the relay will de-energize if the drive is no longer in current limit. See Parameter 16 - CURRENT in Section 18.0 - DESCRIPTION OF PARAMETERS.
- AUT/MAN** AUTO/MANUAL MODE - The relay energizes when the drive is in the AUTOMATIC mode, and de-energizes in the MANUAL mode. Refer to Section 14.2.6 - SPEED REFERENCE SELECTION.
- FLWR PR** FOLLOWER PRESENT - The relay energizes when the analog input reference signal at TB-5B is greater than 2 mA, and de-energizes if the signal falls below 2 mA.
- MIN/MAX** MIN/MAX ALARM - The relay energizes when the feedback signal (in PID mode) or the speed reference signal (in open-loop speed mode) is within the limits set by MIN ALRM and MAX ALRM (Parameters 81 and 82), and de-energizes when the signal falls below the MIN ALRM setting or exceeds the MAX ALRM setting.

## 7.0 INSTALLATION



### Warning

Drives must not be installed where subjected to adverse environmental conditions! Drives must not be installed where subjected to: combustible, oily, or hazardous vapors or dust; excessive moisture or dirt; strong vibration; excessive ambient temperatures. Consult Minarik for more information on the suitability of a drive to a particular environment.

The drive should be mounted on a smooth vertical surface capable of safely supporting the unit without vibrating. The LCD display has an optimum field of view, this should be considered when determining the mounting position.

Chassis models must be installed in an electrical enclosure which will provide complete mechanical protection and maintain uniform internal temperature within the drive's ambient operating temperature rating. All drive models **MUST** be mounted in a vertical position for proper heatsink cooling.

Maintain a minimum spacing around the drive of 2 inches for units rated 5 HP and below, 4 inches for units rated 7.5-25 HP, and 6 inches for units rated 30-60 HP.

Fans or blowers should be used to insure proper cooling in tight quarters. Do not mount drives above other drives or heat producing equipment that would impede the cooling of the drive. Note the ambient operating temperature ratings for each drive model.

If it is necessary to drill or cut the drive enclosure or panel, extreme care must be taken to avoid damaging drive components or contaminating the drive with metal fragments (which cause shorting of electrical circuits). Cover drive components with a clean cloth to keep out metal chips and other debris. Use a vacuum cleaner to clean drive components after drilling, even if chips do not appear to be present. Do not attempt to use positive air pressure to blow chips out of drive, as this tends to lodge debris under electronic components. Contaminating the drive with metal chips can cause drive failure and will void the warranty.

The AC400 Series is UL approved for solid state motor overload protection. Therefore, a separate thermal overload relay is not required for single motor applications. In applications where one drive is operating more than one motor, a separate thermal overload relay is required for each motor per NEC.

## 7.1 INSTALLATION AFTER A LONG PERIOD OF STORAGE



### **Warning**

Severe damage to the drive can result if operated after long periods of storage or inactivity without reforming the DC bus capacitors!

If input power has not been applied to the drive for a period of time exceeding three years (due to storage, etc), the electrolytic DC bus capacitors within the drive can change internally, resulting in excessive leakage current. This can result in premature failure of the capacitors if the drive is operated after such a long period of inactivity or storage.

In order to reform the capacitors and prepare the drive for operation after a long period of inactivity, apply input power to the drive for 8 hours prior to actually operating the drive/motor system.

## 7.2 EXPLOSION PROOF APPLICATIONS

Explosion proof motors that are not rated for inverter use lose their certification when used for variable speed. Due to the many areas of liability that may be encountered when dealing with these applications, the following statement of policy applies:

**“Minarik Corporation inverter products are sold with no warranty of fitness for a particular purpose or warranty of suitability for use with explosion proof motors. Minarik Corporation accepts no responsibility for any direct, incidental or consequential loss, cost, or damage that may arise through the use of its AC inverter products in these applications. The purchaser expressly agrees to assume all risk of any loss, cost, or damage that may arise from such application. Minarik Corporation or Minarik Corporation’s engineering department will not knowingly approve applications involving explosion proof motors.”**

## 8.0 INPUT AC REQUIREMENTS



### Warning

Hazard of electrical shock! Disconnect incoming power and wait three minutes before servicing the drive. Capacitors retain charge after power is removed.

## 8.1 INPUT AC POWER REQUIREMENTS

### 8.1.1 VOLTAGE:

The input voltage must match the drive's nameplate voltage rating. Voltage fluctuation must not vary by greater than 10% overvoltage or 15% undervoltage.

### NOTE

Drives with dual rated input voltage must be programmed for the proper supply voltage - see Parameter 0 (LINE VOLTS) in Section 18.0 (DESCRIPTION OF PARAMETERS).

The drive is suitable for use on a circuit capable of delivering not more than 200,000 RMS symmetrical amperes, at the drive's rated voltage.

Three phase voltage imbalance must be less than 2.0% phase to phase. Excessive phase to phase imbalance can cause severe damage to the drive's power components.

Motor voltage should match line voltage in normal applications. The drive's maximum output voltage will equal the input voltage. Use extreme caution when using a motor with a voltage rating which is different from the input line voltage.

### 8.1.2 kVA RATINGS:

If the kVA rating of the AC supply transformer is greater than ten times the input kVA rating of the drive, a drive isolation transformer, or a 2 - 3% input line reactor (also known as a choke) must be added.

## 8.2 INPUT FUSING AND DISCONNECT REQUIREMENTS

A circuit breaker or a disconnect switch with fuses must be provided in accordance with the National Electric Code (NEC) and all local codes.

The AC400 drive is capable of withstanding up to 150% current overload for 60 seconds. Select a fuse or magnetic trip circuit breaker rated at 1.5 times the input current rating of the drive (the minimum fuse size should be 10 amps, regardless of input current rating). Refer to Section 5.0 (AC400 RATINGS).



Minimum voltage rating of the protection device should be 250 Vac for 240/120 Vac and 240/200 Vac rated drives, and 600 Vac for 480/400 Vac and 590/480 Vac drives.

Current limiting type fuses should be used when input fusing is required. Select fuses with low I<sup>2</sup>T values, rated at 200,000 AIC. Recommended fuses are Bussman type KTK-R. Similar fuses with equivalent ratings by other manufacturers may also be acceptable.

## **9.0 VOLTAGE SELECTION**

### **9.1 INPUT VOLTAGE RATINGS**

AC4x1 Series drives are rated for 240/120 Vac, 50-60 Hz input. The drive will function with input voltage of 120 Vac (+ 10%, -15%) at 48 to 62 Hz when wired for 120 Vac input, or with input voltage of 240 Vac (+ 10%, - 15%), at 48 to 62 Hz, when wired for 240 Vac input.

AC4x2 Series drives are rated for 240/200 Vac, 50-60 Hz input. The drive will function with input voltages of 200 to 240 Vac (+ 10%, - 15%), at 48 to 62 Hz.

AC4x4 Series drives are rated for 480/400 Vac, 50-60 Hz input. The drive will function with input voltages of 400 to 480 Vac (+ 10%, - 15%), at 48 to 62 Hz.

AC4x5 Series drives are rated for 590/480 Vac, 50-60 Hz input. The drive will function with input voltages of 480 to 590 Vac (+ 10%, - 15%), at 48 to 62 Hz.

## 10.0 POWER WIRING



### **Warning**

Hazard of electrical shock! Disconnect incoming power and wait three minutes before servicing the drive. Capacitors retain charge after power is removed.

Note drive input and output current ratings and check applicable electrical codes for required wire type and size, grounding requirements, overcurrent protection, and incoming power disconnect, before wiring the drive. Size conservatively to minimize voltage drop.

Input fusing and a power disconnect switch or contactor **MUST** be wired in series with terminals L1, L2, and L3 (L1 and L2 if input is single phase). If one has not been supplied by Minarik Corporation, a disconnect means must be wired during installation. This disconnect must be used to power down the drive when servicing, or when the drive is not to be operated for a long period of time, but should not be used to start and stop the motor. Repetitive cycling of a disconnect or input contactor (more than once every two minutes) may cause damage to the drive.

### 10.1 WIRING FOR SINGLE PHASE OR THREE PHASE INPUT

If the drive is nameplated for 240/120 Vac single phase input, wire the input to terminals L1 and N and jumper terminals L1 to L2 for 120 Vac input voltage, or wire to terminals L1 and L2 (do not wire to N) for 240 Vac input voltage. Refer to Section 11.0 (AC400 POWER WIRING DIAGRAM).

If the drive is nameplated for three phase input only, wire the input to terminals L1, L2, and L3.

All three power output wires, from terminals T1, T2, and T3 to the motor, must be kept tightly bundled and run in a separate conduit away from all other power and control wiring.

Do not install contactors between the drive and motor without consulting Minarik Corporation for more information.

# 11.0 AC400 POWER WIRING DIAGRAM

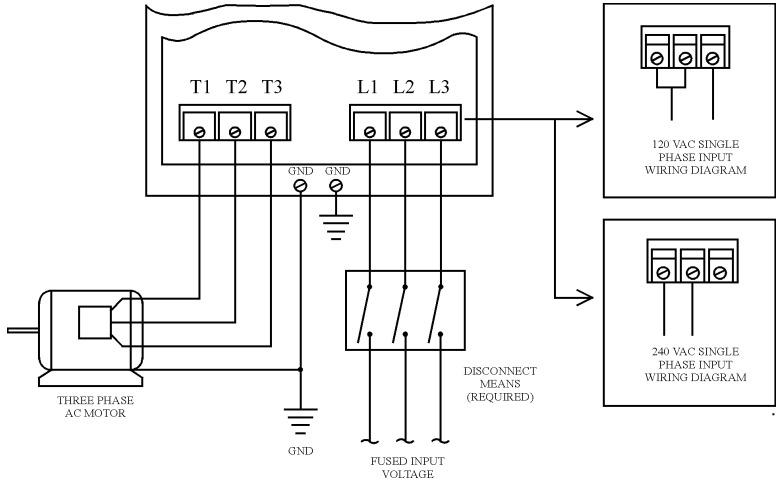

**Warning**  
 Do not connect incoming AC power to output terminals T1, T2, or T3. This will result in severe damage.

INSTALL, WIRE, AND GROUND IN ACCORDANCE WITH ALL APPLICABLE CODES.

**NOTES:**

1. Wire the motor for the proper voltage per the output rating of the drive. Motor wires **MUST** be run in a separate steel conduit away from control wiring and incoming AC power wiring.
2. Do not install contactors between the drive and the motor without consulting Minarik for more information. Failure to do so may result in drive damage.
3. Remove any existing, and do not install, power factor correction capacitors between the drive and the motor. Failure to do so will result in drive damage.
4. Use only UL and CSA listed and approved wire.
5. Minimum wire voltage ratings: 300 V for 120, 200 and 240 Vac systems, and 600 V for 400, 480, and 590 Vac systems.
6. Wire gauge must be based on a minimum of 150% of the rated output current of the drive, and a minimum 75°C insulation rating. Use copper wire only.
7. Wire and ground in accordance with NEC or CEC, and all applicable local codes.

## 12.0 INITIAL POWER UP



### Warning

Hazard of electrical shock! Wait three minutes after disconnecting incoming power before servicing the drive. Capacitors retain charge after power is removed.

Before attempting to operate the drive, motor, and driven equipment be sure all procedures pertaining to installation and wiring have been properly followed.



### Warning

Severe damage to the drive can result if operated after long periods of storage or inactivity without reforming the DC bus capacitors!

If input power has not been applied to the drive for a period of time exceeding three years (due to storage, etc), the electrolytic DC bus capacitors within the drive can change internally, resulting in excessive leakage current. This can result in premature failure of the capacitors if the drive is operated after such a long period of inactivity or storage.

In order to reform the capacitors and prepare the drive for operation after a long period of inactivity, apply input power to the drive for 8 hours prior to actually operating the drive/motor system.

Disconnect the driven load from the motor. Verify that the drive input terminals (L1, L2, and L3) are wired to the proper input voltage per the nameplate rating of the drive.



### Warning

DO NOT connect incoming AC power to output terminals T1, T2, and T3! Do not cycle input power to the drive more than once every two minutes. This will result in damage to the drive.

Energize the incoming power line. The LCD display should light and flash “TESTING” and then show the voltage and horsepower rating of the drive. The display should then show “STOP 20.00 HZ” which indicates that the drive is in a STOP condition, and the speed setpoint is 20.00 Hz:



STOP 20.00 HZ

If the display does not appear, remove the incoming power, wait three minutes for the bus capacitors to discharge, and verify correct installation and wiring. If the wiring is correct, re-apply incoming power and note the display for drive status. If the display still does not appear call the factory for assistance.

If the drive powers up correctly, follow the procedure given below to check the motor rotation:

1. Verify that there is a wire jumper between terminals TB-1 and TB-2 on the Main Control Board. The drive should have this jumper from the factory. If it is not present, add one, otherwise the drive will not start.
2. Use the DOWN ARROW key to decrease the speed setpoint to the minimum value allowed (0.50 Hz if Parameter 10 - MIN FRQ has not been changed).
3. Press the START key. The drive should indicate RUN, but if the speed setpoint is 0.50 Hz, the motor may not rotate. Press the UP ARROW key to increase the speed setpoint until the motor starts to rotate.
4. If the motor is rotating in the wrong direction, press the STOP key and remove power from the drive. Wait three minutes for the bus capacitors to discharge, and swap any two of the motor wires connected to T1, T2, and T3.

**NOTE**

The drive is phase insensitive with respect to incoming line voltage. Therefore, to change the motor rotation, the phases must be swapped at the drive output terminals or at the motor.

## 13.0 KEYPAD CONTROL

The drive can be operated in a number of different ways: keypad (LOCAL), control devices wired to the terminal strip (REMOTE), serial communications (SERIAL), or combinations of each. The drive should first be operated from the keypad during initial start-up. Refer to Sections 14.0 - CONTROL WIRING, and 18.0 - DESCRIPTION OF PARAMETERS for information on remote operation.

### 13.1 KEYPAD FUNCTIONS

#### START/STOP

To start the drive, press the START key. To stop the drive, press the STOP key.

**NOTE 1:** A jumper may need to be installed between TB-1 and TB-2 in order to START the drive in LOCAL mode (refer to Parameter 30 - CONTROL).

**NOTE 2:** The STOP key is active in both LOCAL and REMOTE modes.

#### SPEED SETPOINT

To increase the speed setpoint, press the ▲ key. To decrease the speed setpoint, press the ▼ key.

**NOTE:** The ▲ and ▼ keys are only active if another speed reference source is not selected.

#### LOCAL/REMOTE

To toggle between LOCAL and REMOTE mode, press the LOCAL/REMOTE key to select the desired mode, and then press the ENTER key within three seconds to confirm the change.

**NOTE:** Parameter 30 - CONTROL must be set to KEYPAD or KEYPAD 2 for this key to be active.

#### AUTO/MANUAL

To toggle between AUTOMATIC (terminal strip) and MANUAL (keypad) speed control, press the AUTO/MAN key to select the desired mode, and then press the ENTER key within three seconds to confirm the change.

**NOTE:** Parameter 28 - AUTO/MAN must be set to A/M LOC or A/M SPD for this key to be active. See Section 14.0 - CONTROL WIRING for information on automatic speed reference sources.

## FAULT RESET

Use the STOP key to reset a fault. If the fault condition has passed, pressing the STOP key will clear the fault and return the drive to a STOP condition.

**NOTE:** If an OUTPUT fault occurs, there will be a 30 second delay before the fault can be cleared using the STOP key.

## 13.2 AC400 DISPLAY

The following describes the possible display configurations for the AC400 Series drive when operating as a standard drive (without PID control). Refer to Section 19.0 - AC400 PID SETPOINT CONTROL for a complete description of drive operation when using PID control.

### 13.2.1 AC400 DISPLAY IN STOP MODE

When the drive is in the STOP mode, there are three possible displays. The first is the SPEED display, which looks like this:

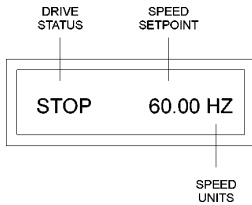

**NOTE:** See Parameter 31 - UNITS for the SPEED UNITS display options.

Pressing the ENTER key will change the display from the SPEED indication to the % LOAD indication:

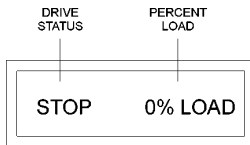

Pressing the ENTER key again will change the display from the % LOAD indication to the VAC (motor voltage) indication:

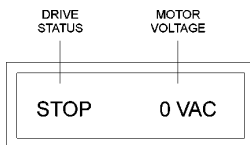

Pressing ENTER again will change the display back to the SPEED indication.

The following table shows the possible DRIVE STATUS indications that can appear on the drive display:

<b>DRIVE STATUS TABLE</b>	
DISPLAY	DESCRIPTION
STOP	Drive is in STOP mode - No output to the motor.
RUN	Drive is in RUN mode and is within $\pm 3$ Hz of the speed setpoint.
FAULT	Drive has shut down due to a FAULT condition. If the fault condition has passed, pressing the STOP key will clear the fault and return the drive to the STOP mode.
LOCK	Drive is in FAULT LOCKOUT after five unsuccessful restart attempts.
BRAKE	DC BRAKE is energized.
LIMIT	Drive is in CURRENT LIMIT due to an overloaded motor, or ACCEL is set too fast.
F DEC	Drive is in DECEL FREEZE because DECEL is set too fast.



### 13.2.2 AC400 DISPLAY IN RUN MODE

When the drive is in the RUN mode, the default display will look like this:

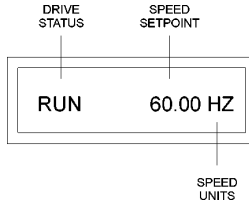

As in the STOP mode, the ENTER key can be used to toggle the display from SPEED to % LOAD to VAC (motor voltage):

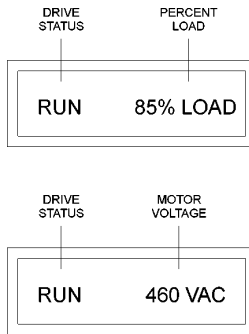

**NOTE:** During acceleration and deceleration to the SPEED SETPOINT, the DRIVE STATUS will show the actual drive speed. When the SPEED SETPOINT is reached, the DRIVE STATUS will change to RUN (or STOP if the drive is decelerating to a STOP).

### 13.2.3 AC400 DISPLAY IN FAULT MODE

When the drive trips on a fault, the display will automatically change to the FAULT display, which indicates the FAULT MESSAGE:

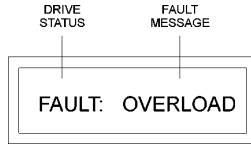

In FAULT mode, the ENTER key will toggle the display between four screens: FAULT, SPEED, % LOAD and VAC. The DRIVE STATUS for these displays will be FAULT. An example is shown below of the drive in the FAULT mode displaying SPEED.

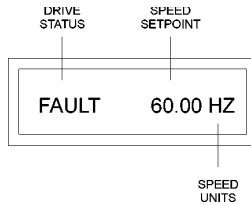

**NOTE:** To clear a FAULT, press the STOP key, issue a remote STOP command at TB-1, or use TB-13D (refer to Parameter 50 - TB13D).

### 13.2.4 AC400 DISPLAY IN AUXILIARY MODE

If the ENTER key is held down, the display will enter the auxiliary mode and cycle between two displays: a CONTROL display that indicates the control source (LOCAL, REMOTE, or SERIAL), AUTO or MANUAL mode, and the speed reference source, and a TIME display that indicates total elapsed run time. When the ENTER key is released, the display will return to the previous screen. Examples of the auxiliary mode displays are shown below:

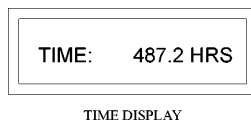
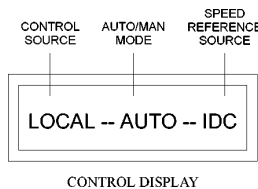

The table below shows the possible SPEED REFERENCE SOURCE indications for the CONTROL display in the auxiliary mode:

SPEED REFERENCE SOURCE TABLE	
DISPLAY	DESCRIPTION
KEY	KEYPAD - UP and DOWN arrow keys.
VDC	0 - 10 VDC analog input at TB-5A (In PID mode, this indicates that the SETPOINT reference is a 0-10 VDC signal).
IDC	4 - 20 mA analog input at TB-5B (In PID mode, this indicates that the SETPOINT reference is a 4-20 mA signal).
SP#1	PRESET SPEED #1
SP#2	PRESET SPEED #2
SP#3	PRESET SPEED #3
SP#4	PRESET SPEED #4
MKB	MANUAL KEYBOARD - UP and DOWN arrow keys are used for speed control. This occurs in PID mode when the drive is in MANUAL mode.
AKB	AUTO KEYBOARD - UP and DOWN arrow keys are used as the SETPOINT reference. This occurs in PID mode when the drive is in AUTO mode and no other setpoint reference is selected.

## 14.0 CONTROL WIRING

### 14.1 GENERAL

#### 14.1.1 KEYPAD CONTROL

The drive can be controlled by the keypad or by control devices wired to the terminal strip. The drive will run from the keypad “out of the box”, as long as the factory jumper between TB-1 and TB-2 is present, as shown below. If the jumper is not present, add one, otherwise the drive will not start from the keypad. Refer to Section 13.0 (KEYPAD CONTROL).

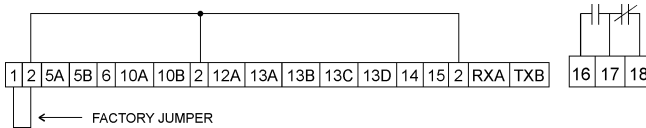

#### 14.1.2 CONTROL WIRING VS. POWER WIRING

External control wiring **MUST** be run in a separate conduit away from all other input and output power wiring. If control wiring is not kept separate from power wiring, electrical noise may be generated on the control wiring that will cause erratic drive behavior. Use twisted wires or shielded cable grounded at the drive chassis **ONLY**. Recommended control wire is Belden 8760 (2-wire) or 8770 (3-wire), or equivalent.

#### 14.1.3 TB-2: CIRCUIT COMMON

The TB-2 terminals are used as circuit common for the start/stop, input select, local/remote, analog input, and analog output functions. There are three TB-2 terminals available on the terminal strip, and they are all internally connected to each other on the main control board. If necessary TB-2 may be connected to chassis ground.

**NOTE:** TB-2 **MUST** be connected to chassis ground when using serial communications.

#### 14.1.4 SURGE SUPPRESSION ON RELAYS

Current and voltage surges and spikes in the coils of contactors, relays, and solenoids, near or connected to the drive can cause erratic drive operation. A snubber circuit should be used on relay and contactor coils associated with the inverter. For AC loads, snubbers should consist of a resistor and a capacitor in series across the coil. For DC loads, a free-wheeling or flyback diode should be placed across the coil.

## **14.2 START/STOP AND SPEED CONTROL**

### **14.2.1 REMOTE MODE SELECTION**

In order to respond to external START/STOP commands, the drive must be in the REMOTE mode. The REMOTE mode can be selected by one of three methods on the AC400 drive:

1. Program Parameter 30 - CONTROL to REMOTE.
2. Program Parameter 30 - CONTROL to KEYPAD or KEYPAD 2, which activates the LOCAL/REMOTE key on the keypad. Press the LOCAL/REMOTE key to select REMOTE mode, and then press the ENTER key within three seconds.
3. Program Parameter 30 - CONTROL to TB STRIP, and program the function of terminal TB-13A or TB-13C (Parameter 47 or 49) to LOCAL SELECT. DO NOT make a contact closure between TB-13A or TB-13C and TB-2 (making the contact closure will select LOCAL mode).

### **14.2.2 TWO-WIRE START/STOP CONTROL**

A two-wire start/stop circuit can be accomplished as follows:

1. Select REMOTE mode (see above).
2. Connect a jumper between TB-12A and TB-2 to provide a permanent START command to the drive.
3. Wire a normally open maintained contact between TB-1 and TB-2. Close this contact to RUN the drive and open this contact to STOP the drive.

Refer to the wiring diagram in Section 15.2.

### **14.2.3 THREE-WIRE START/STOP CONTROL**

A three-wire start/stop circuit can be accomplished as follows:

1. Select REMOTE mode (see above).
2. Wire a normally closed momentary STOP contact between TB-1 and TB-2. Momentarily open this contact to STOP the drive.
3. Wire a normally open momentary START contact between TB-12A and TB-2. Momentarily close this contact to START the drive.

Refer to the wiring diagram in Section 15.3.

## 14.2.4 SPEED REFERENCE SIGNALS

The drive allows for three analog speed reference inputs: a speed potentiometer (10,000 Ohm), 0-10 VDC, or 4-20 mA.

- SPEED POT**            Connect the wiper to terminal TB-5A, and connect the high and low end leads to terminals TB-6 and TB-2, respectively.
- 0-10 VDC**            Wire the positive to terminal TB-5A and the negative to terminal TB-2. TB-5A input impedance is 200 kilohms.
- 4-20 mA**             Wire the positive to terminal TB-5B and the negative to terminal TB-2. TB-5B input impedance is 100 Ohms.

## 14.2.5 SPEED REFERENCE SELECTION

### AUTO/MAN vs. LOCAL/REMOTE

For the AC400 Series drive, operating in standard (non-PID) mode, AUTO/MAN refers to speed control, and LOCAL/REMOTE refers to START/STOP control. AUTOMATIC and MANUAL speed control selection is affected by whether the drive is in LOCAL or REMOTE mode, as described below. Refer to Section 19.0 - AC400 PID SETPOINT CONTROL for a complete description of drive operation when using the PID control function.

### AUTO/MAN SELECTION IN LOCAL MODE

In LOCAL mode (keypad start/stop control), AUTOMATIC and MANUAL selection is determined by Parameter 28 - AUTO/MAN. When Parameter 28 is set to A/M LOC or A/M SPD, the AUTO/MAN key on the keypad is active and can be used to toggle between MANUAL (keypad) and AUTOMATIC (0-10 VDC, 4-20 mA, or preset speeds) speed control. This is done by pressing the AUTO/MAN key to select the desired mode, and then pressing the ENTER key within three seconds to confirm the change.

When AUTOMATIC mode is selected, one of the TB-13 input selects must be programmed to select the desired speed reference, and that TB-13 terminal must be closed to TB-2. The drive will then respond to the automatic speed reference. If the contact closure is not made between the TB-13 terminal and TB-2, the drive will remain in AUTO mode, but speed control will default to the keypad. Therefore, if the Form C relay or open-collector outputs are set to indicate AUTO/MAN mode, they will still indicate AUTO mode.

## AUTO/MAN SELECTION IN REMOTE MODE

In REMOTE mode (terminal strip start/stop control), speed control is either selected using the AUTO/MAN key (Parameter 28 - AUTO/MAN must be set to A/M SPD to do this), or by using the TB-13 input selects.

If AUTOMATIC mode is selected using the AUTO/MAN key (Parameter 28 - AUTO/MAN must be set to A/M SPD to do this), and a speed reference is not selected using one of the TB-13 input selects, the drive will remain in AUTO mode, but speed control will default to the keypad. Therefore, if the Form C relay or open-collector outputs are set to indicate AUTO/MAN mode, they will still indicate AUTO mode.

If the drive is configured to select AUTOMATIC mode by using one of the the TB-13 input selects, closing the TB-13 terminal to TB-2 selects AUTOMATIC mode, and opening the TB-13 terminal selects MANUAL (keypad) mode. Therefore, if the TB-13 terminal is not closed to TB-2, and the Form C relay or open-collector outputs are set to indicate AUTO/MAN mode, they will indicate MANUAL mode.

## 0 - 10 VDC and 4 - 20 mA INPUT SIGNALS

TB-13A, TB-13B, and TB-13C can all be programmed to select 0-10 VDC or 4-20 mA input.

## PRESET SPEEDS

TB-13A can be programmed to select SPEED #1, TB-13B to select SPEED #2, and TB-13C to select SPEED #3. Closing any two of these terminals to TB-2 will select SPEED #4. Refer to Parameters 1-4: SPEED #1 - #4 in Section 18.0 - DESCRIPTION OF PARAMETERS.

## MOP - MOTOR OPERATED POT

TB-13A and TB-13B are used for this function, which sets the speed of the drive using contacts wired to the terminal strip. Program TB-13A to select DEC FREQ, and program TB-13B to select INC FREQ. Closing TB-13A to TB-2 will activate the DEC FREQ function, and will cause the speed setpoint to decrease until the contact is opened. DEC FREQ will operate when the drive is in RUN mode or STOP mode. Closing TB-13B to TB-2 will activate the INC FREQ function, and will cause the speed setpoint to increase until the contact is opened. INC FREQ will only operate when the drive is in RUN mode.

### **NOTE**

If TB-13A, TB-13B, and TB-13C are all programmed to select speed references, and two or three of the terminals are closed to TB-2, the higher terminal has priority and will override the others. For example, if TB-13A is programmed to select 0-10VDC, and TB-13C is programmed to select PRESET SPEED #3, closing both terminals to TB-2 will cause the drive to respond to PRESET SPEED #3, because TB-13C overrides TB-13A.

## **14.2.6 ANALOG OUTPUT SIGNALS**

There are two terminals that can supply analog output signals proportional to output frequency or load. Terminal TB-10A can provide a 0-10 VDC or a 2-10 VDC signal proportional to output frequency, and TB-10B can provide the same signals proportional to load. The 2-10 VDC signals can be converted to a 4-20 mA signal using a resistor in series with the signal such that the total circuit resistance is 500 Ohms. See Parameters: 42 - TB10A OUT, 43 - @TB10A, 44 - TB10B OUT, and 45 - @TB10B in Section 18.0 - DESCRIPTION OF PARAMETERS.

## **14.2.7 DRIVE STATUS OUTPUT CONTACTS**

The control board has one Form C relay at terminals TB-16, TB-17, and TB-18. Contacts are rated 2 amps at 28 VDC or 120 Vac.

There are also two open-collector outputs at terminals TB-14 and TB-15. The open-collector circuit is a current-sinking type rated at 30 VDC and 40 mA maximum. An external power supply (30 VDC max) must be used to power the open-collector outputs. The drive does not have a dedicated power supply for the open-collector outputs.

The Form C relay and the open collector outputs can be programmed to indicate any of the following: RUN, FAULT, /FAULT (INVERSE FAULT), LOCK (FAULT LOCKOUT), @ SPEED (AT SPEED), ABOVE #3, I LIMIT (CURRENT LIMIT), AUTO/MAN mode, FLWR PR (FOLLOWER PRESENT), or MIN/MAX (MIN/MAX ALARM). See Parameters: 52 - TB14 OUT, 53 - TB15 OUT, and 54 - RELAY. Refer to Section 6.2.5 for a complete description of each of these status indications.



# 15.0 AC400 CONTROL WIRING DIAGRAMS

## 15.1 AC400 TERMINAL STRIP

Shown below is the terminal strip on the main control board, along with a brief description of the function of each terminal. Wiring shown above the terminal strip indicates internal wiring on the main control board.

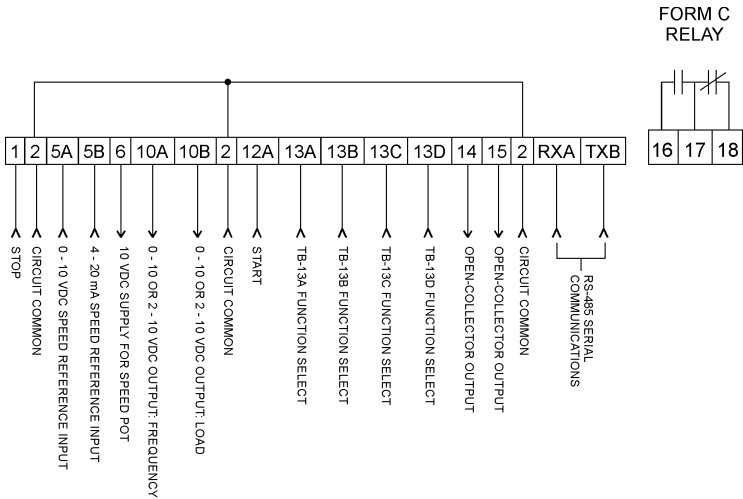

### NOTE

The function of terminals TB-10A, TB-10B, TB-13A, TB-13B, TB-13C, TB-13D, TB-14, TB-15, TB-16, and TB-18 are dependent on the programming of certain parameters. In most cases, the name of the parameter matches the number of the terminal, allowing quick and easy programming of the terminals to suit the application. The exception is TB-16 and TB-18, which are governed by Parameter 54 - RELAY.

A complete description of operating the drive in the REMOTE mode can be found in Section 14.2. The following diagrams provide a quick reference to wire the drive for the most common configurations.



### 15.3 THREE-WIRE START/STOP CONTROL

Shown below is the wiring diagram for a typical three-wire start/stop control scheme, using momentary contacts (such as pushbuttons) for START and STOP commands. Also shown is the wiring for a 0-10 VDC or 4-20 mA speed reference signal.

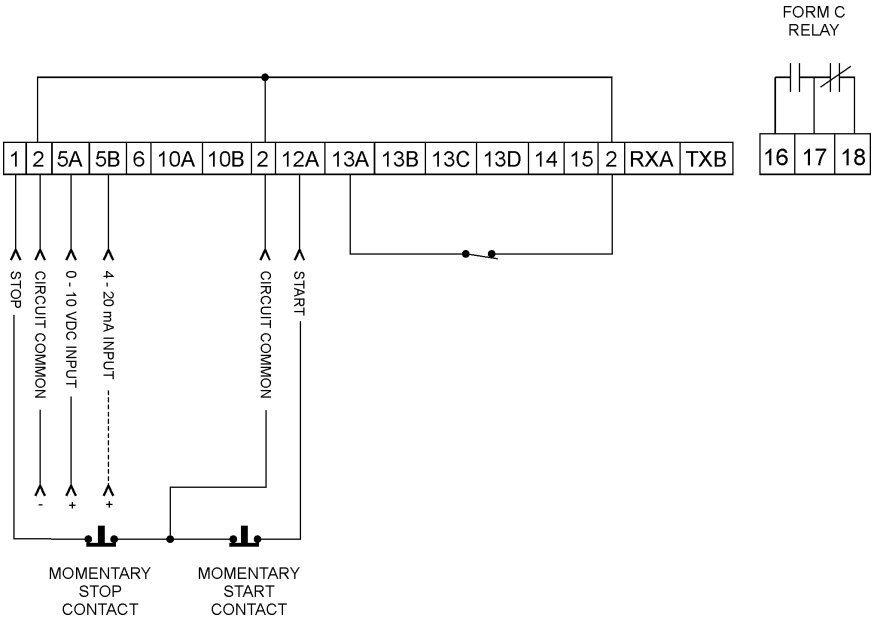

#### NOTES:

1. Momentarily close TB-12A to TB-2 to START, and momentarily open TB-1 to TB-2 to STOP.
2. Program TB-13A, 13B, or 13C to select desired speed reference signal. Close the selected TB-13 terminal to TB-2 to cause the drive to respond to the selected speed reference signal. In the diagram above, TB-13A is the terminal programmed to select the speed reference (either 0-10 VDC or 4-20 mA).
3. If the contact closure is not made between TB-13A and TB-2, the drive will default to keypad speed control.

## 15.4 SPEED POT AND PRESET SPEED CONTROL

Shown below is the wiring diagram for a control scheme that utilizes a speed pot and PRESET SPEEDS for speed control, and either a two-wire or three-wire START/STOP circuit:

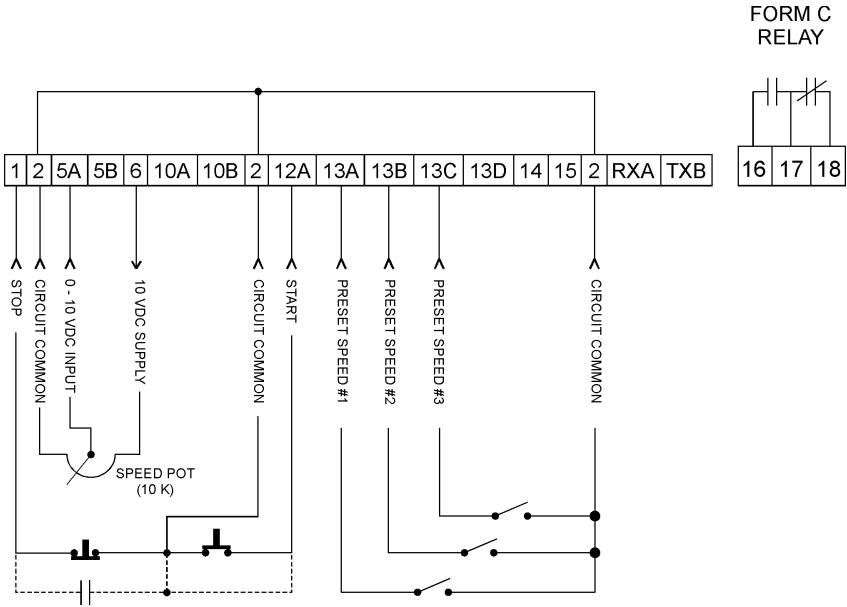

### NOTES:

1. Program the preset speeds to the desired values (see Parameters 1-4: SPEED #1 - #4).
2. Program TB-13A to select SPEED #1, TB-13B to select SPEED #2, and TB-13C to select SPEED #3 (see Parameters 47, 48 and 49).
3. To select a preset speed, close the appropriate preset speed terminal to TB-2. To select SPEED #4, close any two of the three preset speed terminals to TB-2.
4. For speed pot control, one of the TB-13 terminals needs to be programmed to select 0-10 VDC. Close the selected TB-13 terminal to TB-2 for speed pot control. This will result in the loss of one of the preset speeds.
5. If none of the preset speeds (or the speed pot) are selected via contact closures, the drive will default to keypad speed control.

## 16.0 PROGRAMMING THE AC400 DRIVE

### 16.1 PROGRAMMING THE PARAMETERS

The AC400 keypad serves two purposes: operating the drive when in the LOCAL mode, and programming the parameters for particular applications. The keypad is shown below, along with the display that should appear when the drive is first powered up:

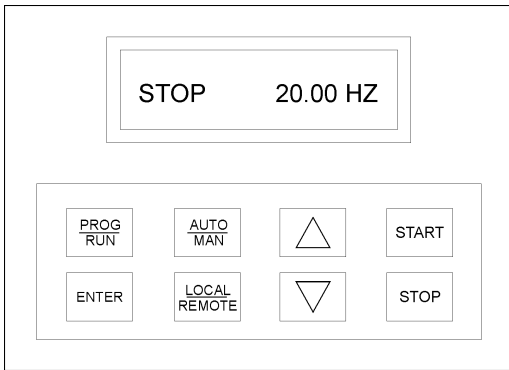

To program the drive, the PROGRAM mode must be entered by pressing the PROG/RUN button. If the password protection is disabled, pressing the PROG/RUN button will result in direct entry into the PROGRAM mode. If the password protection is enabled, the PASSWORD prompt will appear when an attempt is made to enter the PROGRAM mode. The PASSWORD prompt appears as follows:

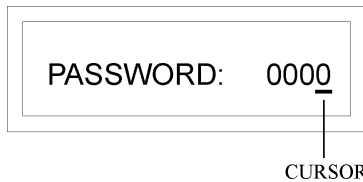

To enter the password, use the UP and DOWN arrow keys to scroll to the password value, and then press the ENTER key.

**NOTE:** The factory default password is 0019.

Once the correct password is entered, the PROGRAM mode will be entered and the first parameter will be displayed, which is Parameter 0 - LINE VOLTS. This is shown below:

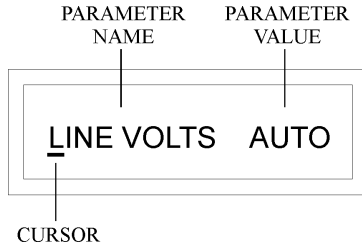

To scroll through the parameters, use the UP and DOWN arrow buttons on the keypad. When the desired parameter is found, press the ENTER key to shift the cursor from the parameter name to the parameter value. In this example, the cursor shifts from LINE VOLTS to AUTO:

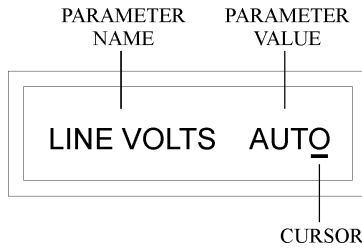

The parameter value can then be changed using the UP and DOWN arrow buttons. If the parameter has a numerical value, the UP arrow will increase the value and the DOWN arrow will decrease the value. If the parameter has specific choices that can be selected, the UP and DOWN arrow keys will scroll through the list of possible settings. When the desired value or option is selected, press the ENTER key to store the new setting. If the new setting is not ENTERED, it will not take effect and the old setting will still be valid.

If the PROG/RUN key is pushed while the cursor is highlighting the parameter value, the value will change back to the original setting (if it had been changed, but not ENTERED), and the cursor will shift back to the parameter name. Pressing PROG/RUN again will exit the PROGRAM mode. If the PROGRAM mode is entered again within two minutes, the last parameter that was viewed, or changed, will come up on the display. After two minutes has elapsed, the password will have to be entered again when attempting to access the PROGRAM mode.

## 16.2 PARAMETER ACCESS USING SPEED DIAL

SPEED DIAL is used to access parameters quickly using the parameter number. Once accessed, the parameter can be programmed as described in Section 16.1. SPEED DIAL is accessed by pressing the AUTO/MAN key while in the PROGRAM mode. This will activate the SPEED DIAL display as shown below:

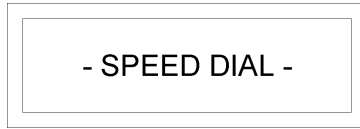

Once in SPEED DIAL, the UP and DOWN arrow keys will allow the operator to scroll through the parameter numbers. The display will continue to show SPEED DIAL while scrolling through the parameter numbers, as shown below:



When the desired parameter is reached, the SPEED DIAL display will be replaced by the parameter name:



Once the desired parameter is displayed on the screen, press the ENTER key to display the parameter name and present setting. The parameter setting can now be changed by the method described in Section 16.1. Press the AUTO/MAN key to return to SPEED DIAL.

**NOTE:** SPEED DIAL is only active in AC400 drives which have the Modbus® serial communications protocol. Units that have the Metasys® protocol do not have this feature.

## 17.0 PARAMETER MENU

PARAMETER MENU			
PARAM. NUMBER	PARAMETER NAME	RANGE OF ADJUSTMENT	FACTORY DEFAULT
0	LINE VOLTS	HIGH, LOW, AUTO	AUTO
1	SPEED #1	MIN FRQ - MAX FRQ	20.00 Hz
2	SPEED #2	MIN FRQ - MAX FRQ	20.00 Hz
3	SPEED #3	MIN FRQ - MAX FRQ	20.00 Hz
4	SPEED #4	MIN FRQ - MAX FRQ	20.00 Hz
5	SKIP #1	.00 Hz - MAX FRQ	.00 Hz
6	SKIP #2	.00 Hz - MAX FRQ	.00 Hz
7	BAND WID	.00 - 10.00 Hz	1.00 Hz
8	ACCEL	(NOTE 1)	30.0 SEC
9	DECEL	(NOTE 1)	30.0 SEC
10	MIN FRQ	.00 - MAX FRQ	.50 Hz
11	MAX FRQ	MIN FRQ - 120.0 Hz	60.00 Hz
12	DC BRAKE	(NOTE 1)	.0 VDC
13	DC TIME	.0 - 999.9 SEC	.0 SEC
14	DYN BRAKE	OFF, ON	OFF
16	CURRENT	25 - 180 % (NOTE 2)	180 %

**Note 1:** Refer to Section 18.0 - Description of Parameters.

**Note 2:** If line volts is set to “low” (or set to “auto” and the input voltage is low), the range is 25 - 150%



<b>PARAMETER MENU</b>			
<b>PARAM. NUMBER</b>	<b>PARAMETER NAME</b>	<b>RANGE OF ADJUSTMENT</b>	<b>FACTORY DEFAULT</b>
17	MOTOR OL	25 - 100 %	100%
18	BASE	20.00 - 360.0 Hz	60.00 Hz
19	FX BOOST	.0 - 30.0 %	(NOTE 1)
22	TORQUE	CONSTANT, VARIABLE, CT / NOCMP	CONSTANT
23	CARRIER	2.5, 6, 8, 10, 12, 14 kHz	2.5 kHz
25	START	NORMAL, POWER-UP, AUTO 1, AUTO 2, AUTO 3	NORMAL
26	STOP	RAMP, COAST	COAST
28	AUTO/MAN	A / M LOC, AUTO, MANUAL, A / M SPD	A / M LOC
30	CONTROL	LOCAL, REMOTE, SERIAL, KEYPAD, TB STRIP, KEYPAD 2	LOCAL
31	UNITS	sp: HERTZ, RPM, % HZ, /SEC, /MIN, /HR, NONE  pid: %, PSI, FPM, CFM, GPM, IN, FT, /SEC, /MIN, /HR, F, C, MPM	sp HERTZ
32	HZ MULT	.10 - 650.0	1.00
33	UNITS DP	XXXXX, XXX.X, XX.XX, X.XXX, .XXXX	XXXXX
34	LOAD MLT	95 - 139 %	100%

**Note 1:** Refer to Section 18.0 (Description of Parameters).

## PARAMETER MENU

PARAM. NUMBER	PARAMETER NAME	RANGE OF ADJUSTMENT	FACTORY DEFAULT
35	CONTRAST	LOW, MED, HIGH	HIGH
39	TB5 MIN	.00 - 360.0 Hz	.00 Hz
40	TB5 MAX	.00 - 360.0 Hz	60.00 Hz
42	TB10A OUT	NONE, 0-10V, 2-10V	NONE
43	@TB10A	3.00 - 360.0 Hz	60.00 Hz
44	TB10B OUT	NONE, 0-10V, 2-10V	NONE
45	@TB10B	10 - 200 %	125 %
47	TB13A	NONE, 0-10VDC, 4-20MA, SPEED#1, LOC SEL, DEC FREQ	NONE
48	TB13B	NONE, 0-10VDC, 4-20MA, SPEED#2, INC FREQ	NONE
49	TB13C	NONE, 0-10VDC, 4-20MA, SPEED#3, LOC SEL	NONE
50	TB13D	EXT FAULT, EXT /FAULT, EXT CLEAR	EXT FAULT
52	TB14 OUT	NONE, RUN, FAULT,	NONE
53	TB15 OUT	/FAULT, LOCK, @ SPEED,	
54	RELAY	ABOVE#3, I LIMIT, AUT/MAN, FLWR PR, MIN/MAX	
55	TB5B LOSS	FAULT, SP#4	FAULT
57	SERIAL	DISABLE, W/TIMER, W/O TIMR	DISABLE
58	ADDRESS	1 - 255 (Metasys) 1 - 247 (Modbus)	30

<b>PARAMETER MENU</b>			
<b>PARAM. NUMBER</b>	<b>PARAMETER NAME</b>	<b>RANGE OF ADJUSTMENT</b>	<b>FACTORY DEFAULT</b>
61	PASSWORD	0000 - 9999	0019
63	SOFTWARE	(VIEW - ONLY)	(N/A)
64	MONITOR	OFF, ON	ON
65	PROGRAM	MAINTAIN, RESET 60, RESET 50	RESET 60
66	HISTORY	MAINTAIN, CLEAR	MAINTAIN
70	PID MODE	OFF, NORMAL, REVERSE	OFF
74	PID FB	TB-5A, TB-5B	TB-5A
75	FB @ MIN	0 - 65000	0.0%
76	FB @ MAX	0 - 65000	100.0%
77	P GAIN	0.0 - 999.9%	5.00%
78	I GAIN	0.0 - 10.0 SEC	0.0 SEC
79	D GAIN	0.0 - 10.0 SEC	0.0 SEC
80	PID ACC	0.0 - 100.0 SEC	30.0 SEC
81	MIN ALRM	FB @ MIN - FB @ MAX	0.0%
82	MAX ALRM	FB @ MIN - FB @ MAX	0.0%
98	LANGUAGE	(NOTE 1)	ENGLISH
99	FAULT HISTORY	(VIEW - ONLY)	(N/A)

**Note 1:** Refer to Section 18.0 - Description of Parameters.

## 18.0 DESCRIPTION OF PARAMETERS

### 0 LINE VOLTS (LINE VOLTAGE)

This parameter calibrates the drive for the correct input voltage, and can be set to AUTO, HIGH, or LOW.

When set to AUTO, the drive measures the DC bus voltage when power is applied and automatically calibrates itself according to the measured value (DC bus voltage is equal to input voltage multiplied by 1.4).

This parameter can also be set “manually”, using the HIGH or LOW settings. For actual line voltages of 220 - 240 Vac (on 240/200 Vac models), 460 - 480 Vac (on 480/400 Vac models), or 575 - 600 Vac (on 590/480 Vac models), set this parameter to HIGH. Also use the HIGH setting for 240/120 Vac single-phase input models. Refer to the table below.

For actual line voltages of 200 - 208 Vac (on 240/200 Vac models), 380 - 415 Vac (on 480/400 Vac models), or 460 - 480 Vac (on 590 Vac models), set this parameter to LOW. Refer to the table below.

INPUT LINE VOLTAGE SELECTION				
MODEL	RATED INPUT VOLTAGE	INPUT PHASE	ACTUAL INPUT VOLTAGE	PARAM. SETTING
AC4x1S	240 / 120 Vac	1	220 - 240 Vac	HIGH
	240 / 120 Vac	1	110 - 120 Vac	HIGH
AC4x2S	240 Vac	1	220 - 240 Vac	HIGH
AC4x2T	240 / 200 Vac	3	220 - 240 Vac	HIGH
	240 / 200 Vac	3	200 - 208 Vac	LOW
AC4x4T	480 / 400 Vac	3	460 - 480 Vac	HIGH
	480 / 400 Vac	3	380 - 415 Vac	LOW
AC4x5T	590 / 480 Vac	3	575 - 600 Vac	HIGH
	590 / 480 Vac	3	460 - 480 Vac	LOW

### 1-4 SPEED #1- #4 (PRESET SPEEDS #1, #2, #3, AND #4)

PRESET SPEEDS are only active when the drive is in AUTO mode, and are activated via contact closures between terminal TB-2 and terminals TB-13A, TB-13B, and TB-13C. These terminals must be programmed as preset speed selects using Parameters 47 - 49: TB13A, TB13B, and TB13C.

The preset speeds can only be set to values that are within the operating range defined by the minimum and maximum frequency (see Parameters 10 and 11).

The following table shows how each preset speed is selected using the TB-13 terminals. The terms OPEN and CLOSED refer to the state of the TB-13 terminal relative to TB-2.

PRESET SPEED ACTIVATION			
SPEED #	TB - 13A	TB - 13B	TB - 13C
1	CLOSED	OPEN	OPEN
2	OPEN	CLOSED	OPEN
3	OPEN	OPEN	CLOSED
4	CLOSED	CLOSED	OPEN
	CLOSED	OPEN	CLOSED
	OPEN	CLOSED	CLOSED

**5,6 SKIP #1 & #2 (SKIP SPEED #1 & #2)**

**7 BAND WID (SKIP BANDWIDTH)**

These parameters are used to prevent the drive from operating continuously at critical frequencies that cause excessive mechanical vibration of the driven equipment. The SKIP SPEEDS (Parameters 5 and 6) and the SKIP BANDWIDTH (Parameter 7) are used to define up to two speed avoidance ranges. The SKIP SPEED settings define the starting point of the speed range that is to be avoided, and the SKIP BANDWIDTH setting defines how far the speed range extends beyond SKIP SPEED. Setting the SKIP SPEEDS to .00 Hz disables this function.

Example: The critical frequency is 21 Hz, and a bandwidth of 2 Hz is desired. Therefore, set SKIP #1 to 20 Hz and set SKIP BANDWIDTH to 2 Hz. This results in a speed range from 20 Hz to 22 Hz that the drive will not operate within continuously. If the drive were operating at 25 Hz and then commanded to operate at a speed within the range of avoidance, the drive would decelerate to 22 Hz and remain at that frequency until commanded to 20 Hz or below. The drive would then decelerate through the range of avoidance to the new frequency. Likewise, if the drive were operating at 18 Hz, and then commanded to operate at a speed within the range of avoidance, the drive would accelerate to 20 Hz and remain at that frequency until commanded to a speed of 22 Hz or above. The drive would then accelerate through the range of avoidance to the new frequency.

**8 ACCEL (ACCELERATION TIME)**

ACCEL sets the acceleration rate for all speed reference sources (keypad, speed pot, 4-20 mA, 0-10 VDC, jog, and the preset speeds). The ACCEL setting is the time to accelerate from 0 Hz to the BASE FREQUENCY (Parameter 18). The range of adjustment for ACCEL depends on horsepower. Refer to the table below:

ACCELERATION LIMITS	
HORSEPOWER	RANGE OF ADJUSTMENT
0.25 - 20	0.1 - 3600 SEC
25 - 60	0.3 - 3600 SEC

Example: If ACCEL is set to 30 seconds, and the BASE FREQUENCY is set to 60 Hz, the drive will ramp from 0 Hz to 60 Hz in 30 seconds. This is a linear function, therefore the drive would ramp up to 30 Hz in 15 seconds, etc.

**NOTE:** The ability to accelerate a given load at a particular rate is limited by the output power capability of the drive/motor combination. The acceleration of high-inertia and high-friction loads may be affected by the current limiting characteristics of the drive. See Parameters: 16 - CURRENT, 19 - FX BOOST, and 20 - AC BOOST for more information.

**9 DECEL (DECELERATION TIME)**

DECEL sets the deceleration rate for all speed reference sources. The DECEL setting is the time to decelerate from BASE FREQUENCY to 0 Hz. As with Parameter 8 - ACCEL, this is a linear function. If the drive is set to coast to a stop, DECEL will have no effect when a STOP command is given. The range of adjustment for DECEL depends on horsepower, voltage, and whether Dynamic Braking (DB) is being used. Refer to the table below:

DECELERATION LIMITS				
HORSEPOWER / VOLTAGE RATING			RANGE OF ADJUSTMENT	
240 / 200 VAC (NOTE 1)	480 / 400 VAC	590 / 480 VAC	WITHOUT DB (NOTE 2)	WITH DB
0.25 - 7.5 HP	1 - 7.5 HP	----	0.3 - 3600 SEC	0.1 - 3600 SEC
10 - 15 HP	10 - 20 HP	1 - 7.5 HP	0.5 - 3600 SEC	0.1 - 3600 SEC
20 - 30 HP	25 - 60 HP	10 - 20 HP	1.0 - 3600 SEC	0.2 - 3600 SEC
----	----	25 - 60 HP	2.0 - 3600 SEC	0.2 - 3600 SEC

**NOTE 1:** 240/120 Vac units have the same limits as 240/200 Vac units.

**NOTE 2:** This parameter can be set as low as the value shown in the WITH DB column. However, the value shown in the WITHOUT DB column is the operational limit of a drive without dynamic braking. For example, DECEL can be set as low as 0.1 seconds on a 10 HP, 480 Vac drive without dynamic braking, but the actual minimum deceleration time would be 0.5 seconds.

If an attempt is made to decelerate a high-inertia load too quickly, the motor will regenerate voltage back into the drive. This will cause the DC bus voltage to rise, which can result in a HI VOLTS fault. In order to prevent faulting, the drive will enter DECEL FREEZE, which halts the deceleration until the DC bus voltage returns to a normal level. The drive will then begin to decelerate again, and if necessary, will enter DECEL FREEZE repeatedly to avoid faulting. If a very short deceleration time is programmed, DECEL FREEZE may not be able to compensate fast enough, resulting in a HI VOLTS fault.

In applications where very short deceleration times are required on high-inertia loads, dynamic braking may be required. Consult the factory for more information on the Dynamic Braking option.

**10 MIN FRQ (MINIMUM FREQUENCY)**

This parameter defines the lower limit of the drive's speed range. MIN FRQ is used in conjunction with MAX FRQ (Parameter 11 below) to define the operating range of the drive.

If MIN FRQ is set to a value above 0.0 Hz, the drive will ramp up from 0.0 Hz when given a start command. Once running, however, the drive will not operate below the MIN FRQ setting unless the rotation is changed, or a stop command is issued and the drive is programmed to ramp to a stop.

If the MINIMUM FREQUENCY is set to 0.0 Hz, the drive may be operated in ZERO SPEED mode (drive is in RUN state, but there is no output to the motor). ZERO SPEED operation can be used in applications requiring the ability to start and stop the drive using only the selected speed reference. The drive will start when the speed reference is raised above 0 VDC or 4 mA, and it will stop when the reference is lowered to 0 VDC or 4 mA. Note that the drive must be initially started using one of the normal start commands (keypad or terminal strip).

## 11 MAX FRQ (MAXIMUM FREQUENCY)

This parameter defines the upper limit of the drive's speed range. MAX FRQ is used in conjunction with MIN FRQ (Parameter 10 above) to define the operating range of the drive.



### Warning

Consult motor manufacturer before operating motor above rated frequency. Overspeeding the motor and/or driven equipment can cause damage to equipment and injury to personnel!

## 12 DC BRAKE (DC BRAKE VOLTAGE)

DC braking creates a braking torque by injecting DC voltage into the motor. This parameter sets the magnitude of that DC voltage. The point at which the drive applies DC braking to the motor depends on which STOP mode is programmed (either COAST or RAMP, see Parameter 26 - STOP).

If the drive is set to COAST, DC braking is activated when the stop command is given. In this case, DC braking helps decelerate the motor. This is useful in applications where a quick deceleration is desired on a load that would normally take a long time to coast to a stop.

If the drive is set to RAMP, DC braking is activated when the output frequency reaches 0 Hz. In this case, the drive decelerates the load to a near stop and then DC braking is used to stop and hold the motor. This is useful in applications where the load needs to be stopped in a certain position. Similar applications with high-inertia loads utilize both dynamic braking and DC braking. The dynamic braking allows the high-inertia load to be decelerated quickly, while the DC braking stops the load in the desired position.

Due to heat generated in the motor, DC braking should only be used in applications where the load is stopped infrequently. In high duty-cycle applications, dynamic braking is recommended because the heat is dissipated through external resistor banks, rather than in the motor. When used, DC BRAKE should be set to the lowest voltage that provides satisfactory operation in order to minimize motor heating. The maximum voltage available depends on the voltage rating of the drive. Refer to the table below:

MAXIMUM DC BRAKE VOLTAGE			
MODEL AC4x1 240 / 120 Vac	MODEL AC4x2 240 / 200 Vac	MODEL AC4x4 480 / 400 Vac	MODEL AC4x5 590 / 480 Vac
24 VOLTS	24 VOLTS	48 VOLTS	59 VOLTS



### **13 DC TIME (DC BRAKE TIME)**

This parameter determines the length of time that the DC braking voltage is applied to the motor. DC TIME should be set to the lowest value that provides satisfactory operation in order to minimize motor heating.

**Note:** If this parameter is set to 999.9 seconds (the maximum value), the DC braking will be continuous. If it is set to 0.9 seconds, it is disabled.

### **14 DYN BRAK (DYNAMIC BRAKE)**

This parameter enables the dynamic braking circuit. Set this parameter to ON only if the optional dynamic braking circuit board and resistors are installed.

Dynamic braking is used in applications where high-inertia loads need to be decelerated quickly. When this is attempted, the motor regenerates voltage back into the drive, causing the DC bus voltage to rise, eventually resulting in a HI VOLTS fault. With the dynamic braking option, the DC bus voltage is monitored, and when it reaches a certain level, a transistor is switched on that connects an external resistor bank across the DC bus. This allows the regenerated energy from the motor to be dissipated through the resistors as heat, which keeps the DC bus voltage below the trip level.

### **16 CURRENT (CURRENT LIMIT)**

This parameter sets the maximum allowable output current of the drive, which also determines the torque capability of the motor. For most applications, CURRENT is left at the maximum setting, which is 150% or 180% (of the drive's output current rating), depending on whether the input voltage is low or high (see Parameter 0 - LINE VOLTS). Regardless of the CURRENT setting, the drive is capable of delivering a maximum of 150% current for one minute, and 180% current for approximately 30 seconds, before tripping into an OVERLOAD fault. See Parameter 17 – MOTOR OL below.

The drive will enter current limit when the load demands more current than the drive can deliver, which results in a loss of synchronization between the drive and the motor. To correct this condition, the drive will enter FREQUENCY FOLDBACK, which commands the drive to decelerate in order to reduce the output current and regain synchronization with the motor. When the overcurrent condition passes, the drive will return to normal operation and accelerate back to the speed setpoint. However, if FREQUENCY FOLDBACK cannot correct the condition and the drive remains in current limit for too long, it will trip on an OVERLOAD fault. If the drive enters current limit while accelerating, the time required to reach the speed setpoint will be longer than the time programmed into ACCEL (Parameter 8).

## 17 MOTOR OL (MOTOR OVERLOAD)

The AC400 Series is UL approved for solid state motor overload protection. Therefore, a separate thermal overload relay is not required for single motor applications. The MOTOR OVERLOAD circuit is used to protect the motor from overheating due to excessive current draw.

The trip time for the MOTOR OVERLOAD setting is based on what is known as an “inverse  $I^2t$ ” function. This function allows the drive to deliver 150% of the rated output current for one minute, and even higher current levels for shorter periods of time. Once the overload circuit “times out”, the drive will trip into an OVERLOAD fault.

The MOTOR OVERLOAD should be set to a value which is equal to the ratio (in percentage) of the motor full load current rating to the drive output current rating. This will result in an overload capacity of 150% of the MOTOR current rating for one minute. If this parameter is set to 100%, the motor will be allowed to draw 150% of the DRIVE output current rating for one minute. This distinction is important in cases where the motor full load current rating is significantly less than the drive output current rating, such as applications where the drive is oversized to meet torque requirements.

Example 1: A 5 Hp, 480 Vac drive is operating a 3 HP motor with a full load current rating of 4.8 amps. Divide the motor current rating by the drive output current rating:  $4.8 / 7.6 = 63\%$ . Entering this value will allow continuous operation at 4.8 amps, and will also allow the motor to draw 7.2 amps (150% of 4.8 amps) for one minute. If the setting is left at 100%, the motor could draw 11.4 amps (150% of 7.6 amps) for one minute before faulting.

The AC400Series drive has two options for thermal overload protection. One depends on the speed of the drive, while the other does not. The diagram below illustrates the difference between “speed compensated” and “non-compensated” thermal overload protection.

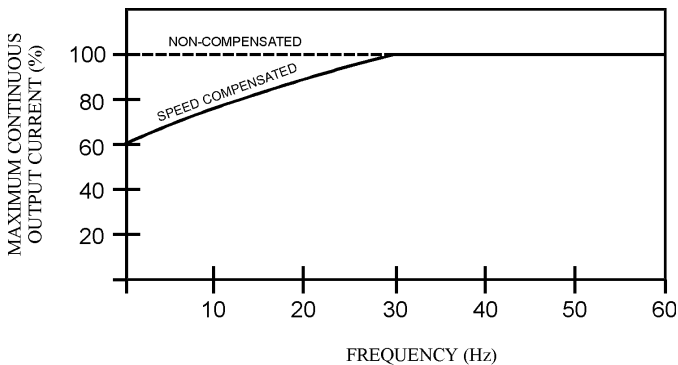

The “speed-compensated” thermal overload circuit offers additional protection from high load conditions at low speeds, where motor cooling is often less effective (e.g., motors with shaft-mounted fans). As seen on the diagram below, the drive reduces the allowable continuous output current when operating at frequencies less than 30 Hz.

Example 2: A 480 Vac, 20 HP drive is operating a motor at 10 Hz. From the diagram, a drive operating at 10 Hz can deliver about 75% of its output current rating continuously. A 480 Vac, 20 HP drive's output current rating is 27 Amps. Therefore, the drive would be able to operate continuously at 20 Amps. The drive would also be able to deliver 150% of that value (30 Amps) for one minute before tripping into an OVERLOAD fault.

The "speed compensated" thermal overload is the factory default and should be used in applications where the motor does not normally experience high loads at low speeds for extended periods of time.

**NOTE 1:** The above diagram is based on a MOTOR OL setting of 100%. For lower MOTOR OL settings, reduce the % CURRENT values by the same percentage. For example, if MOTOR OL is set to 75%, reduce the % CURRENT values by 25%. Therefore, the curve shifts down, but the shape of the curve remains the same.

The "non-compensated" thermal overload circuit allows 100% current continuously, and 150% current for one minute, at all speeds. In the example above, the motor operating at 10 Hz without "speed-compensated" protection would be allowed to operate continuously at 27 Amps, and could draw 40.5 Amps for one minute before tripping. Without sufficient motor cooling, this can result in motor failure due to overheating.

The "non-compensated" circuit is selected by setting Parameter 22 - TORQUE to CT/NOCOMP. The "non-compensated" setting should only be used in applications where the motor is properly cooled at all speeds, or the motor manufacturer has approved the motor for full-load operation at low speeds.

**NOTE 2:** The operation of the motor thermal overload circuit is affected by the setting of Parameter 34 (LOAD MLT).

## **18 BASE (BASE FREQUENCY)**

The BASE FREQUENCY determines the V/Hz ratio by setting the frequency at which the drive will output full voltage to the motor. For most applications the base frequency should be set to match the motor's rated frequency.

For example, if the drive is rated for 460 Vac output, and the BASE FREQUENCY is set to 60 Hz, the drive will maintain a constant ratio of 7.66 V/Hz (except when FX BOOST is active, see Parameter 19) from 0 Hz to 60 Hz. This range is the region of constant torque. If the motor speed is increased past 60 Hz, the output voltage remains constant while the frequency increases, resulting in a reduced V/Hz ratio. This range, from 60 Hz to about 90 Hz, is the region of constant horsepower. Above 90 Hz, horsepower begins to decrease as frequency increases. Refer to Section 6.1 - DESCRIPTION OF AC MOTOR OPERATION.

**19 FX BOOST (FIXED BOOST)**

This parameter is used in applications which require high starting torque. FX BOOST increases the output voltage at lower output frequencies (below 30 Hz for 60 Hz base frequency), in order to boost the torque capability of the motor. Refer to the diagram below. The factory default for FX BOOST depends on the horsepower rating of the drive. Refer to the table below:

FX BOOST FACTORY DEFAULT SETTINGS			
HP	FACTORY DEFAULT	HP	FACTORY DEFAULT
0.25 - 1	5.30 %	15	2.20 %
1.5 - 2	4.40 %	20	2.00 %
3	3.60 %	25	1.80 %
5	3.00 %	30	1.60 %
7.5	2.70 %	40	1.20 %
10	2.40 %	50 - 60	0.80 %

The diagram below illustrates how FX BOOST alters the V/Hz ratio to increase motor torque.

The FX BOOST setting represents the amount of boost at 0 Hz (approximately 15% in the example below), and as the output frequency approaches 30 Hz, the boost decreases to zero. Therefore, at 30 Hz and above, the V/Hz ratio returns to its “normal” state.

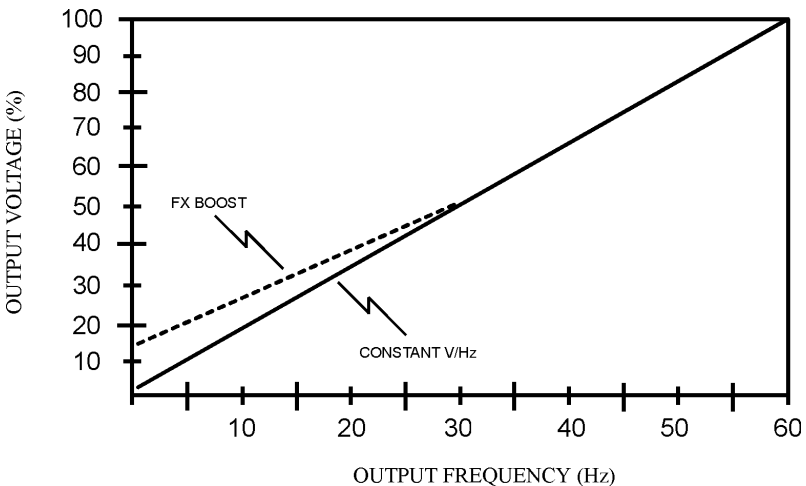

**22 TORQUE (TORQUE CURVE SELECTION)**

This parameter is used to select whether the output of the drive follows a constant or variable V/Hz curve. The following selections are available:

- CONSTANT** Use for constant torque applications to optimize torque.
- VARIABLE** Use for variable torque applications to optimize energy savings.
- CT / NOCMP** Use for constant torque applications that require full overload capacity at low speeds (see Parameter 17 - MOTOR OL).

**23 CARRIER (CARRIER FREQUENCY)**

This parameter sets the carrier frequency, or switching frequency of the output IGBT's. Higher switching rates result in less audible noise to be emitted from the motor, but the efficiency of the drive decreases as the carrier frequency increases. Therefore, this parameter should be set to the lowest value which yields acceptable sound levels. Available settings are: 2.5 kHz, 6 kHz, 8 kHz, 10 kHz, 12 kHz and 14 kHz.

**NOTE 1:** The 2.5 kHz carrier frequency setting is a variable carrier. The carrier frequency remains fixed at 1.5 kHz up to 25 Hz output frequency. Above 25 Hz, the carrier is a fixed multiple of 60 times the drive's output frequency. For example, if the output frequency of the drive was set to 45 Hz, the carrier frequency would be 2.7 kHz (45 Hz x 60 = 2700 Hz). The other settings are constant carriers that remain fixed for the entire speed range.

**NOTE 2:** The ability to operate a drive at higher carrier frequencies is dependent on the drive horsepower rating, driven load, drive enclosure, and the ambient temperature. Operation above 8kHz requires derating the drive by multiplying the output current rating by the following factors: 0.94 at 10 kHz, 0.89 at 12 kHz, and 0.83 at 14 kHz.

**25 START (START MODE)**

 <b>Warning</b> Automatic start of equipment may result in damage to equipment and/or injury to personnel! Automatic start should only be used on equipment that is inaccessible to personnel.
-------------------------------------------------------------------------------------------------------------------------------------------------------------------------------------------------------------------------------------------------------------------------------------

This parameter selects the starting method for the drive, and can be set for one of the following:

- NORMAL**            The drive will start when the appropriate contact closure is made on the terminal strip (REMOTE mode), or by pressing the keypad START key (LOCAL mode). To start the drive in NORMAL mode, a start command must be issued at least two seconds AFTER input power is applied.
  
- POWER UP**        The drive will automatically start upon application of input power. The drive MUST be set up for a two-wire start/stop circuit (refer to Section 14.0 - CONTROL WIRING), and the start command MUST be present when power is applied for this function to operate.
  
- AUTO 1**            FLYING AUTO RESTART - LOW performance. Synchronization in approximately 6 seconds with current levels up to 50% of the drive rating. This setting results in a slow, smooth synchronization.
  
- AUTO 2**            FLYING AUTO RESTART - MEDIUM performance. Synchronization in approximately 1 second with current levels up to 50% of the drive rating. This setting allows faster synchronization while retaining smoothness.
  
- AUTO 3**            FLYING AUTO RESTART - HIGH performance. Synchronization in approximately 1 second with current levels up to 100% of the drive rating. This setting allows the fastest synchronization, but sacrifices smoothness.

The AUTO 1 - 3 settings allow the drive to start into a spinning load after a fault or upon application of input power. As with POWER UP, the drive MUST be set up for two-wire start/stop control and the start command MUST be present after a fault or when power is applied for this function to operate.

POWER UP and AUTO 1 - 3 settings are only active when the drive is in REMOTE mode (see Parameter 30 - CONTROL).

When set for AUTO 1, 2, or 3, the drive will attempt five restarts after a fault. During the interval between restart attempts, the drive will display START PENDING to indicate that the equipment will automatically restart. If all five restart attempts are unsuccessful, the drive will trip into FAULT LOCKOUT, which requires a manual reset. Every 15 minutes that passes will decrement the restart counter by one. Therefore, 75 minutes after a successful restart, the restart counter is fully reset, and the drive can once again attempt five restarts.

**NOTE 1:** When set for AUTO 1, 2, or 3, only the first two restart attempts will perform a speed search to start into a spinning load. The last three restart attempts will apply DC braking (at the voltage level programmed into Parameter 12 - DC BRAKE) for 15 seconds and then start from zero speed.

**NOTE 2:** The drive WILL NOT restart after a CONTROL or PWR SAG fault. Also, if an OUTPUT fault occurs below 1.5 Hz, only one restart will be attempted, after a 30 second delay. If unsuccessful, it will then trip into FAULT LOCKOUT, which requires a manual reset. This is done to protect the drive in case of a shorted motor.

**26 STOP (STOP MODE)**

This parameter selects whether the motor will COAST to a stop, or RAMP to a stop, when the drive is given a stop command.

**COAST** When a stop command is given, the drive shuts off the output to the motor, allowing it to coast to a stop. In this mode, the time it takes the motor to stop is governed by the inertia of the driven load.

**RAMP** When a stop command is given, the drive will decelerate the motor to a stop over a period of time according to Parameter 9 - DECEL.

**28 AUTO / MAN (AUTO / MANUAL SPEED CONTROL)**

This parameter determines how AUTOMATIC and MANUAL speed control is selected, and affects the functionality of the AUTO/MAN key on the keypad.

**A/M LOC** The AUTO/MAN key on the keypad is active only when the drive is in LOCAL mode. In REMOTE mode, the AUTO/MAN key is disabled.

**AUTO** The drive will respond to a 0-10 VDC signal, 4-20 mA signal, or one of the four PRESET SPEEDS, depending on the programming of terminals TB-13A, TB-13B and/or TB-13C. The AUTO/MAN key is disabled.

**NOTE:** If no AUTO reference is selected using TB-13A, TB-13B or TB-13C, speed control defaults to the keypad.

**MANUAL** The drive will respond to the ▲ and ▼ keys on the keypad. The AUTO/MAN key is disabled.

**A/M SPD** The AUTO/MAN key is always active.  
NOTE: If the drive is switched from LOCAL to REMOTE mode, speed control will switch to AUTO. If the drive is switched from REMOTE to LOCAL mode, speed control will switch to MANUAL mode. The AUTO/MAN key can then be used to select the desired mode.

### 30 CONTROL (START/STOP CONTROL)

This parameter selects the START/STOP control source, which is either the keypad (LOCAL), the terminal strip (REMOTE), or the serial link (SERIAL). The LOCAL/REMOTE key on the keypad is also affected by the setting of this parameter. The following settings are possible:

**LOCAL** The drive will only respond to START/STOP commands from the keypad. The LOCAL/REMOTE key is disabled.

**REMOTE** The drive will only respond to START/STOP commands from the terminal strip. The LOCAL/REMOTE key is disabled.

**SERIAL** The drive will only respond to START/STOP commands through the serial link.

**KEYPAD** The LOCAL/REMOTE key on the keypad is enabled and is used to toggle between LOCAL and REMOTE modes. Press the LOCAL/REMOTE key to select the desired mode and then press the ENTER key within three seconds.

**NOTE:** If LOCAL mode is selected, a jumper is required between TB-1 and TB-2 to allow the drive to START.

**TB STRIP** The terminal strip is used to select LOCAL or REMOTE mode. LOCAL mode if TB-13A or TB-13C is set for LOCAL SELECT and a contact closure is made between TB-13A or TB-13C and TB-2. If the contact closure is not made, the drive will be in REMOTE mode.

**KEYPAD 2** Acts the same as KEYPAD, but TB-1 is disabled as a STOP input when LOCAL mode is selected. Therefore, a jumper is not required between TB-1 and TB-2 to START in LOCAL mode.

**NOTE 1:** The STOP key on the keypad is always active. The STOP input at TB-1 is always active unless CONTROL is set to KEYPAD 2 and LOCAL mode is selected.



**NOTE 2:** Refer to Parameter 70 - PID MODE for information on the effects of LOCAL and REMOTE mode when operating the drive in PID mode.

### 31 UNITS (SPEED/PID UNITS)

This parameter sets the units of the output speed or the PID display on the keypad. The following choices are available:

sp HERTZ		pid CFM	(cubic feet per minute)
sp RPM	(revolutions per minute)	pid GPM	(gallons per minute)
sp %HZ	(percent Hertz)	pid IN	(inches)
sp /SEC	(units per second)	pid FT	(feet)
sp /MIN	(units per minute)	pid /SEC	(units per second)
sp /HR	(units per hour)	pid /MIN	(units per minute)
NONE	(no units displayed)	pid /HR	(units per hour)
pid %	(percent of PID feedback)	pid F	(degrees Fahrenheit)
pid PSI	(pounds per square inch)	pid C	(degrees Celsius)
pid FPM	(feet per minute)	pid MPM	(meters per minute)

**NOTE:** If one of the “pid” units is selected, but the drive is in MANUAL (open-loop) speed control mode or PID MODE is DISABLED, the displayed speed units will default to HERTZ.

### 32 HZ MULT (HERTZ MULTIPLIER)

The HZ MULTIPLIER is used to scale the output speed indication on the display. This parameter is only active when UNITS is set for sp RPM, sp /SEC, sp /MIN, or sp /HR. Multiplying the output frequency by the HZ MULTIPLIER will yield the desired speed value on the display.

Example: The desired speed units is RPM with a standard 60 Hz, 1800 RPM motor. Set UNITS to sp RPM and set HZ MULT to 30.00. This will result in a display of 1110 RPM for an output frequency of 37 Hz ( $37 \text{ Hz} \times 30 = 1110 \text{ RPM}$ ). Also, if there is a 100:1 gear reducer in the system, Parameter 33 - UNITS DP below could be set to XX.XX to represent the output of the gear reducer (11.10 RPM in the example).

**33 UNITS DP (SPEED UNITS DECIMAL POINT)**

In “non-PID” mode, UNITS DP selects the decimal point location of the speed display. UNITS DP has no effect if UNITS is set to sp HERTZ or sp % HZ.

In PID mode, UNITS DP selects the decimal point location for the PID SETPOINT and FEEDBACK displays, and FB @ MIN and FB @ MAX.

The possible settings are: XXXXX, XXX.X, XX.XX, X.XXX, and .XXXX. Refer to the above example in Parameter 32 - HZ MULT.

**34 LOAD MLT (LOAD MULTIPLIER)**

This parameter is used to scale the % LOAD display. If the drive output current rating is higher than the motor full load current rating, the drive will not display 100% load when the motor is at full load. Setting this parameter to the ratio (in %) of the drive output current rating to the motor full load current rating will scale the load display to show motor load instead of drive load. This will result in a display of 100% when the motor is at full load.

The motor overload circuitry is also affected by this parameter. When the display reads 150% load, the drive will trip on OVERLOAD in one minute, regardless of the actual motor current. If this parameter is used to scale the display to show actual motor load, then Parameter 17 - MOTOR OL should be left at 100%. Likewise, if MOTOR OL has been set according to the motor full load rating, this parameter should be left at 100%. Changing both parameters will result in an OVERLOAD fault sooner than expected.

The output signal at TB-10B is also affected by this parameter. When set to the ratio of current ratings as explained above, the output signal will be proportional to motor load instead of drive load.

**35 CONTRAST (LCD DISPLAY CONTRAST)**

This parameter is used to adjust the contrast of the drive display and can be set to LOW, MED, or HIGH in order to obtain the most visible display. If the drive is mounted lower than eye level, a HIGH setting may make the display more visible. Likewise, if the drive is mounted higher than eye level, a LOW setting may make the display more visible.

**39 TB5 MIN (TERMINAL TB-5 INPUT)**

This parameter selects the output frequency of the drive that will correspond to the minimum analog speed reference input (0 VDC or 4 mA). This parameter is used in conjunction with Parameter 40 - TB5 MAX to define a speed range for the drive that corresponds to the analog speed reference input (0 - 10 VDC or 4 - 20 mA).

**40 TB5 MAX (TERMINAL TB-5 INPUT)**

This parameter selects the output frequency of the drive that will correspond to the maximum analog speed reference input (10 VDC or 20 mA). This parameter is used in conjunction with Parameter 39 - TB5 MIN to define a speed range for the drive that corresponds to the analog speed reference input (0 - 10 VDC or 4 - 20 mA).

Example: The drive is required to operate from 0 to 60 Hz in response to a 0-5 VDC speed reference signal (rather than the “normal” 0-10 VDC). Because TB5 MAX is based on a 0-10 VDC (or 4-20 mA) signal, the drive will operate at half of the TB5 MAX value if it is given a 5 VDC signal. Therefore, setting TB5 MAX to 120 Hz will cause the drive to run at 60 Hz when it is given a 5 VDC speed reference signal.

**NOTE:** The drive can be programmed for inverse operation so that as the speed reference increases, the drive speed will decrease, and as the speed reference decreases, the drive speed will increase. This is accomplished by setting TB5 MIN to the desired maximum output frequency, and TB5 MAX to the desired minimum output frequency.

**42 TB10A OUT (TERMINAL TB-10A OUTPUT)**

The analog output signal at TB-10A is proportional to the output frequency of the drive. This parameter selects whether that signal is 0-10 VDC or 2-10 VDC. The 2-10 VDC signal can be converted to a 4-20 mA signal by connecting a resistor in series with the signal such that the total circuit resistance is 500 Ohms. If set to NONE, the function is disabled.

**NOTE:** This output cannot be used with “loop-powered” devices that derive power from a 4-20 mA signal.

**43 @ TB10A (TERMINAL TB-10A SCALING)**

This parameter scales the analog output signal at TB-10A. This setting is the output frequency that is indicated when the TB-10A output measures 10 VDC.

Example: The drive is part of a control system that requires a 0-5 VDC signal (rather than 0-10 VDC) that is proportional to 0-60 Hz output frequency. The output signal is linear, so setting this parameter to 120 Hz would yield 10 VDC at 120 Hz, and 5 VDC at 60 Hz.

**44 TB10B OUT (TERMINAL TB-10B OUTPUT)**

The analog output signal at TB-10B is proportional to the drive load. This parameter selects whether that signal is 0-10 VDC or 2-10 VDC. The 2-10 VDC signal can be converted to a 4-20 mA signal by connecting a resistor in series with the signal such that the total load resistance is 500 Ohms.

**NOTE:** This output cannot be used with “loop-powered” devices that derive power from a 4-20 mA signal.

**45 @ TB10B (TERMINAL TB-10B SCALING)**

This parameter scales the analog output signal at TB-10B. This setting is the load (in %) that is indicated when the TB-10B output measures 10 VDC.

Example: The drive is part of a control system that requires a 0-10 VDC signal to indicate 0-150% drive load. If this parameter is set to 150%, the drive will output 10 VDC at 150% load (and about 6.7 VDC at 100% load).

**NOTE:** The output signal at TB-10B is affected by the setting of Parameter 34 (LOAD MLT).

**47 TB13A (TB-13A INPUT FUNCTION)**

This parameter is used to select the function of terminal TB-13A. Closing TB-13A to TB-2 activates the TB - 13A input function. The following functions can be selected:

- NONE**                      Disables the TB-13A function.
- 0-10VDC**                      Selects 0-10 VDC as the AUTO speed reference input (or setpoint source in PID mode). The 0-10 VDC signal is wired to TB-5A and TB-2.

- 4-20 MA**                      Selects 4-20 mA as the AUTO speed reference input (or setpoint source in PID mode). The 4-20 mA signal is wired to TB-5B and TB-2.
- SPEED#1**                      Selects PRESET SPEED #1 as the AUTO speed reference.
- LOC SEL**                      Selects LOCAL mode when Parameter 30 - CONTROL is set to TB STRIP. Drive is in REMOTE mode if contact closure is not made.
- DEC FREQ**                      Decrease frequency setpoint. Used with the MOP (motor operated pot) function. Refer to Section 14.2.6 - SPEED REFERENCE SELECTION.

**48    TB13B                                      (TB-13B INPUT FUNCTION)**

This parameter is used to select the function of terminal TB-13B. Closing TB-13B to TB-2 activates the TB - 13B function. The following functions can be selected:

- NONE**                              Disables the TB-13B function.
- 0-10VDC**                      Selects 0-10 VDC as the AUTO speed reference input (or setpoint source in PID mode). The 0-10 VDC signal is wired to TB-5A and TB-2.
- 4-20 MA**                      Selects 4-20 mA as the AUTO speed reference input (or setpoint source in PID mode). The 4-20 mA signal is wired to TB-5B and TB-2.
- SPEED#2**                      Selects PRESET SPEED #2 as the AUTO speed reference.
- INC FREQ**                      Increase frequency setpoint. Used with MOP (motor operated pot) function. Refer to Section 14.2.6 - SPEED REFERENCE SELECTION.

**49    TB13C                                      (TB-13C INPUT FUNCTION)**

This parameter is used to select the function of terminal TB-13C. Closing TB-13C to TB-2 activates the TB-13C input function. The following functions can be selected:

- NONE**                              Disables the TB-13C function.
- 0-10VDC**                      Selects 0-10 VDC as the AUTO speed reference input (or setpoint source in PID mode). The 0-10 VDC signal is wired to TB-5A and TB-2.
- 4-20 MA**                      Selects 4-20 mA as the AUTO speed reference input (or setpoint source in PID mode). The 4-20 mA signal is wired to TB-5B and TB-2.

- SPEED#3**                 Selects PRESET SPEED #3 as the AUTO speed reference.
- LOC SEL**                LOCAL SELECT - Selects LOCAL mode when Parameter 30 - CONTROL is set to TB STRIP. Drive is in REMOTE mode if contact closure is not made.

**50   TB13D                                 (TB-13D FUNCTION)**

 **Warning**  
 EXTERNAL FAULT (TB-13D) circuitry may be disabled if parameters are reset to factory defaults! The drive must be reprogrammed after a RESET in order to insure proper operation (see Parameter 65 - PROGRAM).  
  
 FAILURE TO DO SO MAY RESULT IN DAMAGE TO EQUIPMENT AND/OR INJURY TO PERSONNEL!

This parameter selects the function for TB-13D.

- EXT FAULT**               Sets TB-13D as a normally open EXTERNAL FAULT contact. Close TB-13D to TB-2 to trip the drive into an EXTERNAL FAULT.
- EXT / FAULT**           Sets TB-13D as a normally closed EXTERNAL FAULT contact. Open TB-13D to TB-2 to trip the drive into an EXTERNAL FAULT.
- EXT CLEAR**             Sets TB-13D as a normally open EXTERNAL FAULT RESET. Close TB-13D to TB-2 to clear a fault.

**NOTE:** When set to EXT CLEAR, TB-13D becomes the only terminal that can be used to clear a fault (TB-1 will not work). However, the keypad STOP key can still be used to clear faults.

**52   TB14 OUT                             (TB-14 OPEN COLLECTOR OUTPUT)**

This parameter sets the open-collector output indication for terminal TB-14. The following conditions can be selected: NONE, RUN, FAULT, / FAULT (INVERSE FAULT), LOCK (FAULT LOCKOUT), @ SPEED (AT SPEED), ABOVE #3, I LIMIT (CURRENT LIMIT), AUTO/MAN mode, FLWR PR (FOLLOWER PRESENT), and MIN/MAX (MIN/MAX ALARM). Refer to Section 6.2.5 - AC400 STATUS OUTPUT RELAYS.

The open-collector output circuit is a current-sinking type rated at 30 VDC and 40 mA maximum. An external power supply (30 VDC max.) must be used to power the open-collector outputs. The drive does not have a dedicated power supply for the open-collector outputs.

**53 TB15 OUT (TB-15 OPEN COLLECTOR OUTPUT)**

This parameter sets the open-collector output indication for terminal TB-15. It has the same functionality as Parameter 52 - TB14 OUT above.

**54 RELAY (RELAY FUNCTION)**

The control board has one set of FORM C contacts that can be programmed for the same indications as the open-collector outputs described above. Refer to Section 6.2.5 - AC400 STATUS OUTPUT RELAYS.

The FORM C relay contacts on TB-16, 17, and 18 are rated 2 Amps at 28 VDC or 120 Vac. Control wiring diagrams show relays in the rest state (coils NOT energized).

**55 TB5B LOSS (LOSS OF FOLLOWER ACTION)**

This parameter selects the action taken by the drive if the follower signal is lost at TB-5B. This function is only active if the follower signal is 4-20 mA. The signal is considered lost if it falls below 2 mA.

**FAULT** The drive will trip into a FOLLOWER fault condition.

**SP #4** The drive will operate at the speed programmed into Parameter 4 - SPEED #4.

**57 SERIAL (SERIAL COMMUNICATIONS)**

This parameter is used to activate serial communications. When using this feature, the drive can communicate with a personal computer (PC), programmable logic controller (PLC), or other external device that utilizes RS-485 serial communications for control. The serial interface may be used to read present parameter settings (uploading to the control device), write new parameter settings (downloading from the control device), monitor present drive activity, and control drive activity. The following settings are available:

- DISABLE**                      Serial communication function is disabled.
  
- W / TIMER**                      Enables serial communications with a watchdog timer. If there is no serial activity (read or write) for more than 10 seconds, serial control will turn off and the drive will stop.
  
- W / O TIMR**                      Enables serial communications without a watchdog timer. However, after 10 seconds of no serial activity, serial control can be turned off by issuing a STOP command from any source (keypad, terminal strip) other than the serial link.

**NOTE 1:** The keypad STOP button and remote STOP input (TB-1) are always active, regardless of what method (LOCAL, REMOTE, or SERIAL) is being used to control the drive.

**NOTE 2:** If a RESET command (Parameter 65 - PROGRAM) is issued through the serial link, this parameter will not default back to DISABLE. However, explicitly setting this parameter to DISABLE through the serial link will cut off communication with the drive.

If developing an application for serial communications, refer to the RS-232/RS-485 Modbus® or Metasys® Communications Protocol Specification.

**58      ADDRESS                      (SERIAL ADDRESS)**

This parameter is used with the serial communications feature, and is intended for use in a multiple drive network (RS-485). The serial link will support drives with addresses from 1 up to 255 (Metasysâ) or 247 (Modbusâ). If the serial communications option is not being used, leave this parameter set to the default setting of 30.

**61      PASSWORD                      (PASSWORD NUMBER)**

This feature limits access to the programmable parameters for added security. The correct password must be entered in order to change the parameters.

Pressing the PROG/RUN button on the keypad will activate the PASSWORD prompt. If the correct password is entered, the PROGRAM MODE is entered and parameters can be changed.

If the wrong password is entered, the display will flash ERROR: INCORRECT and then return to the PASSWORD prompt to allow another attempt at entering the correct password.



If the ENTER key is pressed while PASSWORD reads 0000, the MONITOR MODE will be entered (if Parameter 64 - MONITOR, is set to ON), which will allow the parameters to be viewed (except for PASSWORD), but not changed. MONITOR MODE is not present in units that have the Metasys software option.

**NOTE 1:** The factory default value is 0019.

**NOTE 2:** If PASSWORD is set to 0000, the function is disabled. Pressing the PROG/RUN key will result in direct entry into the PROGRAM mode without having to enter a password.

**63 SOFTWARE (SOFTWARE VERSION)**

This parameter displays the software code and revision number of the control board software. This information is useful when contacting the factory for programming or troubleshooting assistance. This is a “view-only” parameter, and cannot be changed.

**64 MONITOR (MONITOR)**

This parameter is used to enable (ON) or disable (OFF) the MONITOR MODE function. Units with the Metasys software option do not have this feature. The functionality is explained below:

**ON** Pressing the PROG/RUN key will activate the PASSWORD prompt. If the ENTER key is pressed while the password value reads 0000, the MONITOR MODE is entered and parameters can be viewed (except for PASSWORD), but not changed.

**OFF** Pressing the PROG/RUN key will activate the PASSWORD prompt. If the ENTER key is pressed while the password value reads 0000, it will be treated as in incorrect password and the display will flash ERROR: INCORRECT, and then return to the PASSWORD prompt to allow another attempt at entering the correct password.

**65 PROGRAM (PROGRAM FACTORY DEFAULTS)**



**Warning**

EXTERNAL FAULT (TB-13D) circuitry may be disabled if parameters are reset to factory defaults! The drive must be reprogrammed after a RESET in order to insure proper operation (see Parameter 65 - PROGRAM).

FAILURE TO DO SO MAY RESULT IN DAMAGE TO EQUIPMENT AND/OR INJURY TO PERSONNEL!

This parameter is used to reset the programmable parameters back to the factory default settings. This parameter has three possible settings:

**MAINTAIN** Maintain parameter settings as they are.

**RESET 60** Resets parameters to factory defaults for 60 Hz base frequency.

**RESET 50** Resets parameters to factory defaults for 50 Hz base frequency.

**NOTE:** This parameter will display RESET 60 or RESET 50 until a change is made to one or more of the parameter settings. Once a parameter is changed, the display will change to MAINTAIN.

**NOTE:** When a reset is performed, TB-13D will default to a normally open EXTERNAL FAULT contact because Parameter 50 - TB13D will be reset to EXT FAULT.

**66 HISTORY (CLEAR FAULT HISTORY)**

This parameter is used to clear the previous faults in the FAULT HISTORY. When set to CLEAR and the ENTER key is pushed, the display will change to MAINTAIN, and the FAULT HISTORY will display NO FAULT for each of the eight fault histories.

**70 PID MODE (PID MODE SELECT)**

This parameter activates the PID function, and selects whether the PID control will be direct or reverse acting. Refer to Section 19.0 - AC400 PID SETPOINT CONTROL. The following options are available:

**OFF** Disables the PID function to allow “standard” drive operation.

**NORMAL** Enables the PID function for direct acting systems. An increase in the feedback variable will cause a decrease in motor speed.

**REVERSE** Enables the PID function for reverse acting systems. An increase in the feedback variable will cause an increase in motor speed.

**NOTE:** The REVERSE selection is not used to compensate for reverse acting feedback devices. If a reverse acting feedback device is used, program Parameters 75 and 76 - FB @ MIN and FB @ MAX as described in Section 19.1 - FEEDBACK DEVICES.

When PID is enabled, and the drive is in REMOTE and AUTO mode, the drive will operate in a CLOSED LOOP fashion, responding to the feedback signal in order to maintain the process setpoint. In this case, the setpoint reference can be a 0-10 VDC or 4-20 mA signal, or the keypad. The SPEED REFERENCE SOURCE indication in the CONTROL display will indicate VDC (0-10 VDC), IDC (4-20 mA), or AKB (keypad), depending on the setpoint reference.

When PID is enabled, and the drive is in LOCAL and AUTO mode, the drive will also operate in a CLOSED LOOP fashion. However, in this case, the only setpoint reference available is the keypad, and the SPEED REFERENCE SOURCE indication in the CONTROL display will indicate AKB.

When PID is enabled, and the drive is in MANUAL and LOCAL or REMOTE mode, the drive will operate in an OPEN LOOP fashion, responding directly to speed commands from the keypad only. The SPEED REFERENCE SOURCE indication in the CONTROL display will indicate MKB.

When PID is disabled, the drive will operate in an OPEN LOOP mode, responding directly to speed commands from either the keypad (MANUAL mode) or an analog input signal (AUTO mode).

**74 PID FB (PID FEEDBACK SOURCE)**

This parameter selects the terminal to be used for the feedback signal, and can be set to TB-5A or TB-5B. TB-5A is used for 0-10 VDC signals, and TB-5B is used for 4-20 mA signals.

**NOTE:** The AC400 has only one analog input of each type, so the same type of signal cannot be used for feedback and setpoint reference. For example, a 4-20 mA signal from a transducer could not be used as a feedback signal if the setpoint is being controlled by a 4-20 mA signal from a PLC.

**75 FB @ MIN (MINIMUM FEEDBACK VALUE)**

This parameter should be set to the value of the process variable that corresponds to the minimum transducer feedback signal (0 VDC or 4 mA).

**76 FB @ MAX (MAXIMUM FEEDBACK VALUE)**

This parameter should be set to the value of the process variable that corresponds to the maximum transducer feedback signal (10 VDC or 20 mA).

**NOTE:** If a reverse acting feedback device is being used, FB @ MIN should be set to the maximum process variable value, and FB @ MAX should be set to the minimum process variable value.

**77 P GAIN (PROPORTIONAL GAIN)**

This parameter setting represents the speed command output (in % of maximum speed) that results from each 1% of error (1% of Parameter 75 - FB @ MIN or 76 - FB @ MAX, whichever is larger).

Example: If P GAIN is programmed for 5%, and the error (difference between setpoint and feedback) is 10%, the speed command output of the Proportional term is 50% ( $10 \times 5 = 50$ ) of maximum speed.

**78 I GAIN (INTEGRAL GAIN)**

This parameter setting represents the ramp rate of the speed command output (in % of maximum speed per second) that results from each 1% of error.

Example: If I GAIN is programmed for 0.5 seconds, and the error is 5%, the rate of rise of the speed command output of the Integral term is 2.5% ( $0.5 \times 5 = 2.5$ ) of maximum speed per second.

**79 D GAIN (DIFFERENTIAL GAIN)**

This parameter setting represents the speed command output (in % of maximum speed) that results from each 1% per second change in the error.

Example: If D GAIN is programmed for 5 seconds, and the error is increasing at 2% per second, the speed command output of the Differential term is 10% ( $5 \times 2 = 10$ ) of maximum speed.

**NOTE:** Differential gain is used as a “shock-absorber” to dampen overshoots in fast-acting systems. However, it can be very sensitive to “noise” on the feedback signal and to digitizing errors, so it must be used with caution.

**80 PID ACC (PID ACCEL/DECEL)**

This parameter sets the acceleration and deceleration rate of the setpoint reference into the PID unit. When the setpoint changes, this function will “filter” the input to the PID unit by ramping the setpoint reference from the previous value to the new value. This will help prevent overshoots that can occur when the PID control attempts to respond to step changes in setpoint, resulting in smoother operation. If PID ACC is set to 0.0 seconds, it is effectively disabled.

**81 MIN ALARM (PID MINIMUM ALARM)**

This parameter setting represents the value that the feedback signal (in PID mode) or speed reference signal (in open-loop speed mode) must fall below to activate the MIN/MAX ALARM output (see Parameters 52, 53, and 54).

**82 MAX ALARM (PID MAXIMUM ALARM)**

This parameter setting represents the value that the feedback signal (in PID mode) or speed reference signal (in open-loop speed mode) must exceed to activate the MIN/MAX ALARM output (see Parameters 52, 53, and 54).

**NOTE:** The MIN ALARM function can be used to start and stop the drive based on the level of the speed reference signal or PID feedback signal. This is done by wiring a 2-wire start/stop circuit through the drive's Form C relay or open-collector output, and setting the Form C relay or open-collector output for MIN/MAX (see Parameters 52, 53, and 54). When the signal drops below the MIN ALARM setting, the relay or open-collector output will de-energize, which opens the start contact and stops the drive. When the signal is equal to or greater than the MIN ALARM setting, the relay or open-collector output will energize, which closes the start contact and starts the drive. The drive must be in REMOTE mode to use the MIN/MAX function to start and stop the drive.

## 98 LANGUAGE

## (LANGUAGE SELECTION)

The AC400 Series drive can support other languages with the addition of an optional LANGUAGE EEPROM chip installed in socket U11 on the control board of the drive. If the EEPROM is not present, the default language will be ENGLISH. Also, this parameter is not affected when the parameters are reset using Parameter 65 - PROGRAM. Therefore, if a language other than ENGLISH is selected, it will remain in effect after a RESET.

## 99 FAULT HISTORY

The FAULT HISTORY stores the previous eight fault conditions that caused the drive to trip. The information stored here is view-only, it cannot be altered. The FAULT HISTORY can be used to determine if there is a pattern, or trend, to the faults, which may indicate a problem in the system. Refer to Section 20.0 - TROUBLESHOOTING for more information on faults.

The FAULT HISTORY indicates the number of the fault (number 1 is the most recent fault), the fault message, and the status of the drive at the time of the fault. An example is shown below:

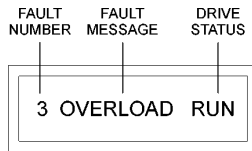

In the example above, the third fault log is being viewed, which is an OVERLOAD fault that occurred while the drive was in a RUN state.

## 19.0 AC400 PID SETPOINT CONTROL

PID Setpoint Control allows the AC400 to maintain a process setpoint, such as PSI or CFM, without using an external controller. When PID is activated, the AC400 will operate in a closed-loop fashion, automatically adjusting the motor speed to maintain the setpoint.

PID setpoint control requires feedback from the process in order to compare the process variable “value” to the setpoint. The difference between the process variable “value” and the setpoint is called the error. The AC400 will increase or decrease the motor speed in an attempt to minimize the error. By constantly adjusting the motor speed, the PID control will drive the process toward the setpoint. Refer to the PID block diagram below:

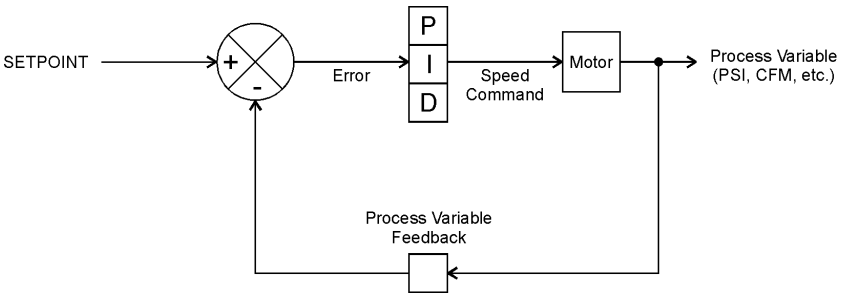

## 19.1 FEEDBACK DEVICES

A transducer or transmitter is required to monitor the process variable and provide feedback to the PID unit in order to compare the process variable feedback to the setpoint. A transducer outputs a signal corresponding to a fixed range of the process variable. A transmitter provides offset and gain adjustments to allow the output signal to be adjusted to correspond to different ranges of the process variable. Typical output signals for transducers and transmitters are: 0-5 VDC, 0-10 VDC, or 4-20 mA. The feedback device must be externally powered, as the drive does not have a power supply for such devices. Program Parameter 74 - PID FB (PID FEEDBACK SOURCE) for the appropriate terminal (TB-5A or TB-5B), and connect the feedback device as described below:

**POT** The positive signal wire (wiper) is connected to TB-5A, and the “high” lead is connected to TB-6.

- |               |                                            |
|---------------|--------------------------------------------|
| 0-5, 0-10 VDC | Connect the positive signal wire to TB-5A. |
| 4-20 mA       | Connect the positive signal wire to TB-5B. |

The common, or negative signal wire, is connected to TB-2 (circuit common).

Feedback devices can be direct or reverse acting. A direct acting device outputs a signal that increases as the process variable increases. A reverse acting device outputs a signal that decreases as the process variable increases. The programming of Parameters 75 - FB @ MIN and 76 - FB @ MAX depend on the type of feedback device being used.

When using a direct acting transducer, Parameter 75 - FB @ MIN should be set to the value of the process variable feedback corresponding to the minimum feedback signal (0 VDC or 4 mA), and Parameter 76 - FB @ MAX should be set to the value of the process variable feedback corresponding to the maximum feedback signal (5 or 10 VDC, or 20 mA). See the example below:

Example 1: A 0-100 psi transducer outputs a 4 mA signal at 0 psi and 20 mA at 100 psi. Program Parameter 75 to 0.0 PSI, and Parameter 76 to 100.0 PSI (This assumes that Parameter 31 - UNITS is set to pid PSI, and Parameter 33 - UNITS DP is set to XXX.X).

For a reverse acting transducer, set Parameter 75 - FB @ MIN to the maximum process variable feedback value, and set Parameter 76 - FB @ MAX to the minimum process variable feedback value. In other words, Parameter 75 is set higher than Parameter 76. See the example below:

Example 2: A 0-100 psi transducer outputs a 20 mA signal at 0 psi and 4 mA at 100 psi. Program Parameter 75 to 100.0 PSI, and Parameter 76 to 0.0 PSI (This assumes that Parameter 31 - UNITS is set to pid PSI, and Parameter 33 - UNITS DP is set to XXX.X).

## **19.2 THE SYSTEM - DIRECT AND REVERSE ACTING**

The entire system can also be direct or reverse acting. In a direct acting system, an increase in motor speed causes an increase in the process variable. This is equivalent to requiring an increase in motor speed in response to a decreasing process variable feedback.

In a reverse acting system, an increase in motor speed causes a decrease in the process variable. This is equivalent to requiring an increase in motor speed in response to an increasing process variable feedback. Examples of direct and reverse acting systems are described in the next section.



### 19.3 PID CONTROL - DIRECT AND REVERSE ACTING

The PID Setpoint Control software can be direct or reverse acting, and must be set to match the system. This is accomplished with Parameter 70 - PID MODE. When set to NORMAL (for direct acting systems), the PID unit will command an increase in motor speed if the process variable feedback decreases, and a decrease in motor speed if the process variable feedback increases. When set to REVERSE (for reverse acting systems), the opposite is true.

**NOTE:** The REVERSE setting for Parameter 70 - PID MODE is not used to compensate for reverse acting feedback devices. If a reverse acting feedback device is used, program Parameters 75 and 76 as described above.

An example of a direct acting system is one that maintains duct pressure. Duct pressure is the process variable that is monitored by the feedback device. As duct pressure rises, motor speed needs to be decreased to maintain the pressure. A direct acting PID control will command a decrease in motor speed in response to an increasing process variable feedback.

An example of a reverse acting system is one that maintains water temperature in a cooling tower. Water temperature is the process variable that is monitored by the feedback device. As the water temperature rises, motor speed needs to be increased to lower the temperature of the water. A reverse acting PID control will command an increase in motor speed in response to an increasing process variable feedback.

### 19.4 SETPOINT REFERENCE SOURCES

The setpoint reference input can be one of the following:

1. Keypad
2. 4-20 mA signal at TB-5B
3. 0-10 VDC signal at TB-5A
4. Potentiometer signal at TB-5A

In order to use TB-5A or TB-5B for a setpoint input, one of the TB-13 terminals must be programmed for the appropriate signal. Closing the TB-13 terminal to TB-2 will then select that signal as the setpoint reference. If the contact closure is not made to TB-2, the setpoint reference source will default to the keypad. See Parameters 47 - TB13A, 48 - TB13B, and 49 - TB13C.

Remote setpoint reference inputs at TB-5A and TB-5B can only be used if that terminal is NOT being used for the process feedback signal from a transducer. The AC400 has only one analog input of each type, so the same type of signal cannot be used for transducer feedback and setpoint reference. For example, a 4-20 mA signal from a transducer could not be used as a feedback signal if the setpoint is being controlled by a 4-20 mA signal from a PLC.

## 19.5 TUNING THE PID CONTROL

Once the PID control is set up correctly, it needs to be tuned in order to maintain the process setpoint. First, set the Integral and Differential Gains to zero, and increase the Proportional Gain (Parameter 77) until the system becomes unstable, then lower the gain until the system stabilizes again. Set the Proportional Gain about 15% less than that value that stabilizes the system. If only Proportional Gain is used, and the system is operating in a steady-state condition (setpoint is fixed and process variable has settled to a fixed value), there will always be a certain amount of error in the system. This is called the steady-state error.

Integral Gain (Parameter 78) is used to force the steady-state error to zero by increasing the output speed command with respect to time. Over time, the error will be forced to zero because the Integral term will continue to change the speed command, even after the Proportional term reaches steady state and no longer affects the speed command. The Integral Gain affects the rate of rise of the output speed command from the Integral term. Small amounts of Integral Gain can cause large changes in PID performance, so care must be taken when adjusting Integral Gain. Too much Integral Gain will result in overshoots, especially if large step changes in error occur.

Typically, Proportional and Integral Gain are all that is needed to fine-tune the system. However, it may be necessary to use Differential Gain (Parameter 79) to further stabilize the system, especially when quick responses are required. The Differential term responds to the rate of change of the error, not the actual error itself. Differential Gain acts like a “shock-absorber” to dampen overshoots that can occur when the PID tries to react quickly to changes in error or setpoint. This allows fast PID response, with reduced risk of becoming unstable due to overshoots. The Differential term is very sensitive to electrical noise on the feedback signal and to digitizing errors, so it must be used with caution.

The other parameter setting that affects the response of the PID control is Parameter 80 - PID ACC. This sets the acceleration (and deceleration) rate of the setpoint reference into the PID unit. When the setpoint changes, this function will “filter” the input to the PID unit by ramping the setpoint reference from the previous value to the new value. This will help prevent overshoots that can occur when the PID control attempts to respond to step changes in setpoint, resulting in smoother operation. If PID ACC is set to 0.0 seconds, it is effectively disabled.

## 19.6 AC400 DISPLAY IN PID MODE

When the drive is in PID mode, the DRIVE STATUS portion of the display will indicate actual output frequency (in Hertz) instead of RUN, and the right side of the display will indicate PID SETPOINT, % LOAD, or PID FEEDBACK. The ENTER key is used to toggle between the different displays. Examples of the possible displays are shown below:

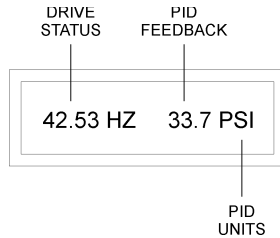
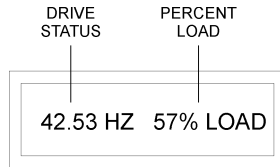
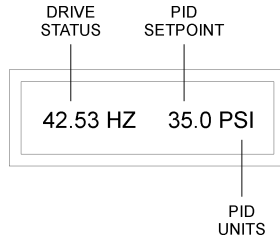

In the examples above, the drive is running at 42.53 Hz to maintain the PID SETPOINT of 35.0 psi. Pressing the ENTER key displays % LOAD, which is 57%. Pressing ENTER again displays the PID FEEDBACK from the process, which is 33.7 psi.

When the PID SETPOINT and PID FEEDBACK displays are entered, the display will flash SETPOINT or FEEDBACK before displaying the value to indicate which display is being viewed.

## 20.0 TROUBLESHOOTING

The table below lists the fault conditions that will cause the drive to shut down, as well as some possible causes. Please contact the factory for more information on troubleshooting faults.

**NOTE:** The drive will not automatically restart after a PWR SAG or a CONTROL fault. Also, if an OUTPUT fault occurs below 1.5 Hz, the drive will only attempt one restart, after a four minute delay. If unsuccessful, it will then trip into FAULT LOCKOUT, which will require a manual reset. This is done to protect the drive in case of a shorted motor.

FAULT MESSAGES		
FAULT	DESCRIPTION	POSSIBLE CAUSES
OUTPUT	Output transistor fault: Output current exceeded 200% of drive rating.	Phase to ground short. Phase to phase short. FX BOOST set too high. Bad transistor module (IPM).
LO VOLTS	Low DC Bus Voltage fault: DC bus voltage below 60% of normal.	Low line voltage.
HI VOLTS	High DC Bus Voltage fault: DC bus voltage above 120% of normal.	High line voltage. Overhauling load. DECEL rate is set too fast.
HI TEMP	Temperature fault: Internal drive temperature too high.	Ambient temperature too high. Fan failure (if equipped).
OVERLOAD	Current Overload fault: Output current rating exceeded for too long.	Drive undersized for the application. Problem with motor and/or driven equipment.
PWR TRAN	Power Transient fault: Low line voltage.	AC line dipped or sagged.
PWR SAG	Power Sag fault: Control board voltage is below tolerance. A new control board has been installed that is different from the previous version.	Erratic AC line. Perform a factory reset using Parameter 65-PROGRAM. This will update the software and allow the fault to be reset.
LANGUAGE	Language fault: Selected language not present	Defective language EEPROM. Language EEPROM (U11) removed after programming.

<b>FAULT MESSAGES</b>		
<b>FAULT</b>	<b>DESCRIPTION</b>	<b>POSSIBLE CAUSES</b>
EXTERNAL	External fault: TB-13D is open or closed to TB-2, depending on setting of Parameter 50 - TB13D.	Check setting of Parameter 50. Check devices wired between TB13D and TB-2.
DB ERROR	Dynamic Brake fault: DB circuit has sensed a resistor overload.	The DB duty cycle is too high, causing the resistors to overheat.
CONTROL	Control Board fault: New software has been installed that is different from the previous version.	Perform a factory reset using Parameter 65-PROGRAM. This will update the software and allow the fault to be reset.
INTERNAL INTERN (#)	Internal fault: The micro-processor has sensed a problem.	Electrical noise on control wiring. Defective microprocessor.
FOLLOWER	Loss of Follower fault: 4-20 mA signal at TB-5B is below 2 mA.	Parameter 55 - TB5B LOSS is set to FAULT.

## 21.0 USER SETTING RECORD

PARAMETER MENU: USER SETTING RECORD			
PARAM. NUMBER	PARAMETER NAME	FACTORY DEFAULT	USER SETTING
0	LINE VOLTS	AUTO	
1	SPEED #1	20.00 Hz	
2	SPEED #2	20.00 Hz	
3	SPEED #3	20.00 Hz	
4	SPEED #4	20.00 Hz	
5	SKIP #1	.00 Hz	
6	SKIP #2	.00 Hz	
7	BAND WID	1.00 Hz	
8	ACCEL	30.0 SEC	
9	DECEL	30.0 SEC	
10	MIN FRQ	.50 Hz	
11	MAX FRQ	60.00 Hz	
12	DC BRAKE	.0 VDC	
13	DC TIME	.0 SEC	
14	DYN BRAKE	OFF	
16	CURRENT	180 %	
17	MOTOR OL	100%	
18	BASE	60.00 Hz	
19	FX BOOST	(NOTE 1)	
22	TORQUE	CONSTANT	
23	CARRIER	2.5 kHz	
25	START	NORMAL	
26	STOP	COAST	
28	AUTO/MAN	A / M LOC	
30	CONTROL	LOCAL	
31	UNITS	sp HERTZ	
32	HZ MULT	1.00	
33	UNITS DP	XXXXXX	
34	LOAD MLT	100%	

**NOTE 1:** REFER TO SECTION 18.0 - DESCRIPTION OF PARAMETERS.

**PARAMETER MENU: USER SETTING RECORD**

PARAM. NUMBER	PARAMETER NAME	FACTORY DEFAULT	USER SETTING
35	CONTRAST	HIGH	
39	TB5 MIN	.00 Hz	
40	TB5 MAX	60.00 Hz	
42	TB10A OUT	NONE	
43	@TB10A	60.00 Hz	
44	TB10B OUT	NONE	
45	@TB10B	125%	
47	TB13A	NONE	
48	TB13B	NONE	
49	TB13C	NONE	
50	TB13D	EXT FAULT	
52	TB14 OUT	NONE	
53	TB15 OUT	NONE	
54	RELAY	NONE	
55	TB5B LOSS	FAULT	
57	SERIAL	DISABLE	
58	ADDRESS	30	
61	PASSWORD	0019	
63	SOFTWARE	(N/A)	
64	MONITOR	ON	
65	PROGRAM	RESET 60	
66	HISTORY	MAINTAIN	
70	PID MODE	OFF	
74	PID FB	TB-5A	
75	FB @ MIN	0.00%	
76	FB @ MAX	100.00%	
77	P GAIN	5.00%	
78	I GAIN	0.0 SEC	
79	D GAIN	0.0 SEC	

**PARAMETER MENU: USER SETTING RECORD**

PARAM. NUMBER	PARAMETER NAME	FACTORY DEFAULT	USER SETTING
80	PID ACC	30.0 SEC	
81	MIN ALRM	0.0%	
82	MAX ALRM	0.0%	
98	LANGUAGE	ENGLISH	
99	FAULT HISTORY	(N/A)	



# Notes

# **Minarik**

Minarik Corporation

901 E. Thompson Avenue, Glendale CA 91201-2011

Sales: 800-646-2745, FAX: 800-394-6334

[www.minarikcorp.com](http://www.minarikcorp.com)

Document Number: 250-0303, Rev. 0

Printed in the U.S.A – 11/00

U.S.A. \$10.00, Outside U.S.A. \$11.00